



VMD421H

Voltage and frequency monitor for undervoltage, overvoltage, underfrequency and overfrequency monitoring in 3(N)AC systems of 70...500 V

Software version D239 V2.3x





Bender GmbH & Co. KG

Postfach 1161 • 35301 Grünberg • Germany
Londorfer Str. 65 • 35305 Grünberg • Germany
Tel.: +49 6401 807-0 • Fax: +49 6401 807-259
E-Mail: info@bender.de • www.bender.de

© Bender GmbH & Co. KG

All rights reserved.
Reprinting only with permission
of the publisher.
Subject to change!

Photos: Bender archive and Bendersystembau archive

Table of contents

1. Important information	5
1.1 How to use this manual	5
1.2 Technical support: service and support	5
1.2.1 First level support	5
1.2.2 Repair service	6
1.2.3 Field service	6
1.3 Training courses	6
1.4 Delivery conditions	7
1.5 Inspection, transport and storage	7
1.6 Warranty and liability	7
1.7 Disposal	8
2. Safety instructions	9
2.1 General safety instructions	9
2.2 Work activities on electrical installations	9
2.3 Intended use	9
3. Function	11
3.1 Device features	11
3.2 Functional description	11
3.3 Fast commissioning for $U_n = 400\text{ V}, 50\text{ Hz}$	12
3.4 Preset function	13
3.5 Automatic self test	13
3.6 Manual self test	14
3.7 Malfunction	14
3.8 Fault memory	14
3.9 Assigning alarms to alarm relays K1/K2	14
3.10 Delay times t, t_{on} and t_{off}	14
3.11 Password protection (on, OFF)	15
3.12 Factory settings FAC	15
3.13 Erasable history memory	15
3.14 Alarm LEDs show which relay is in the alarm state	15
3.15 Starting the device with a simulated alarm S.AL	15
3.16 Frequency alarm in case of measuring voltage failure	16
4. Installation and connection	17

5. Wiring	19
6. Operation and settings	21
6.1 Display elements in use	21
6.2 Function of the operating elements	22
6.3 Menu structure	23
6.4 Display in standard mode	24
6.5 Display in menu mode	25
6.5.1 Parameter query and setting: overview	25
6.5.2 Setting the response values for undervoltage and overvoltage	27
6.5.3 Setting the response values for underfrequency, overfrequency and hysteresis	28
6.5.4 Setting the fault memory and operating mode of the alarm relays ..	29
6.5.5 Assigning alarm categories to the alarm relays	30
6.5.6 Setting delay times	33
6.5.7 Select measurement method	34
6.5.8 Factory setting and password protection	34
6.5.9 Restoring factory settings	35
6.5.10 Manual activation of the preset function	35
6.5.11 Querying device information	36
6.5.12 Querying the history memory	36
6.6 Commissioning	36
6.7 Preset function/Factory settings	37
7. Technical data VMD421H	39
7.1 Tabular data	39
7.2 Standards, approvals and certifications	42
7.3 Ordering information	42
7.4 Change log	42
INDEX	43

1. Important information

1.1 How to use this manual



This manual is intended for **qualified personnel** working in electrical engineering and electronics!

Always keep this manual within easy reach for future reference.

To make it easier for you to understand and revisit certain sections in this manual, we have used symbols to identify important instructions and information. The meaning of these symbols is explained below:



This signal word indicates that there is a **high risk of danger** that will result in **death** or **serious injury** if not avoided.



This signal word indicates a **medium risk** of danger that can lead to **death** or **serious injury**, if not avoided.



This signal word indicates a **low-level risk** that can result in minor or **moderate injury** or **damage to property** if not avoided.



This symbol denotes information intended to assist the user in making **optimum use** of the product.

1.2 Technical support: service and support

For commissioning and troubleshooting Bender offers:

1.2.1 First level support

Technical support by phone or e-mail for all Bender products

- Questions about specific customer applications
- Commissioning
- Troubleshooting

Telephone: +49 6401 807-760*

Fax: +49 6401 807-259

In Germany only: 0700BenderHelp (Tel. and Fax)

E-mail: support@bender-service.de

1.2.2 Repair service

Repair, calibration, update and replacement service for Bender products

- Repair, calibration, testing and analysis of Bender products
- Hardware and software update for Bender devices
- Delivery of replacement devices for faulty or incorrectly delivered Bender devices
- Extended warranty for Bender devices with in-house repair service or replacement devices at no extra cost

Telephone: +49 6401 807-780** (technical issues)
+49 6401 807-784**, -785** (commercial issues)

Fax: +49 6401 807-789

E-mail: repair@bender-service.de

Please send the devices for **repair** to the following address:

Bender GmbH, Repair-Service,
Londorfer Straße 65,
35305 Grünberg

1.2.3 Field service

On-site service for all Bender products

- Commissioning, parameter setting, maintenance, troubleshooting for Bender products
- Analysis of the electrical installation in the building (power quality test, EMC test, thermography)
- Practical training courses for customers

Telephone: +49 6401 807-752**, -762 ** (technical issues)
+49 6401 807-753** (commercial issues)

Fax: +49 6401 807-759

E-mail: fieldservice@bender-service.de

Internet: www.bender.de/en

*Available from 7.00 am to 8.00 pm on 365 days of the year (CET/UTC+1)

**Mo-Thu 7.00 am - 8.00 pm, Fr 7.00 am - 13.00 pm

1.3 Training courses

Bender is happy to provide training regarding the use of test equipment.

The dates of training courses and workshops can be found on the Internet at www.bender.de/en -> Know-how -> Seminars.

1.4 Delivery conditions

The conditions of sale and delivery set out by Bender apply.

For software products, the "Softwareklausel zur Überlassung von Standard- Software als Teil von Lieferungen, Ergänzung und Änderung der Allgemeinen Lieferbedingungen für Erzeugnisse und Leistungen der Elektroindustrie" (software clause in respect of the licensing of standard software as part of deliveries, modifications and changes to general delivery conditions for products and services in the electrical industry) set out by the ZVEI (Zentralverband Elektrotechnik- und Elektronikindustrie e.V., (German Electrical and Electronic Manufacturers' Association) also applies.

Conditions of sale and delivery can be obtained from Bender in printed or electronic format.

1.5 Inspection, transport and storage

Inspect the dispatch and equipment packaging for damage, and compare the contents of the package with the delivery documents. In the event of damage in transit, please contact Bender immediately.

The devices must only be stored in areas where it is protected from dust, humidity and spray or dripping water, and in which the specified storage temperatures can be assured.

1.6 Warranty and liability

Warranty and liability claims in the event of injury to persons or damage to property are excluded if they can be attributed to one or more of the following causes:

- Improper use of the device.
- Incorrect mounting, commissioning, operation and maintenance of the device.
- Failure to observe the instructions in this operating manual regarding transport, commissioning, operation and maintenance of the device.
- Unauthorised changes to the device made by parties other than the manufacturer.
- Non-observance of technical data.
- Repairs carried out incorrectly and the use of replacement parts or accessories not approved by the manufacturer.
- Catastrophes caused by external influences and force majeure.
- Mounting and installation with device combinations not recommended by the manufacturer.

This operating manual, especially the safety instructions, must be observed by all persons working with the device. Furthermore, the rules and regulations that apply for accident prevention at the place of use must be observed.

1.7 Disposal

Abide by the national regulations and laws governing the disposal of this device. Ask your supplier if you are not sure how to dispose of the old equipment.

The directive on waste electrical and electronic equipment (WEEE directive) and the directive on the restriction of certain hazardous substances in electrical and electronic equipment (RoHS directive) apply in the European Community. In Germany, these policies are implemented through the "Electrical and Electronic Equipment Act" (ElektroG). According to this, the following applies:

- Electric and electronic equipment are not to be included in household waste.
- Batteries and accumulators are not to be included in household waste but must be disposed of in accordance with the regulations.
- Old electrical and electronic equipment from users other than private households which was introduced to the market after 13th August 2005 must be taken back by the manufacturer and disposed of properly.

For more information on the disposal of Bender devices, refer to our homepage at www.bender.de/en -> Service & support.

2. Safety instructions

2.1 General safety instructions

Part of the device documentation in addition to this manual is the enclosed "Safety instructions for Bender products".

2.2 Work activities on electrical installations



Only **qualified personnel** are permitted to carry out the work necessary to install, commission and run a device or system.



DANGER

Risk of fatal injury due to electric shock!

Touching live parts of the system carries the risk of:

- An electric shock
- Damage to the electrical installation
- Destruction of the device

Before installing the device and before working on the connections of the device, make **sure** that the system is **de-energised**. The rules for working on electrical systems must be observed.

If the device is used outside the Federal Republic of Germany, the applicable local standards and regulations must be complied with. The European standard EN 50110 can be used as a guide.

2.3 Intended use

The voltage monitor VMD421H monitors 3(N)AC systems in the frequency range of 15...460 Hz for undervoltage, overvoltage, underfrequency and overfrequency.

The devices are designed for the nominal voltage range $U_n = 70 \dots 500$ V. The device is internally supplied by the nominal voltage U_n to be monitored.

In order to meet the requirements of the applicable standards, customised parameter settings must be made on the equipment in order to adapt it to local equipment and operating conditions. Please heed the limits of the area of application indicated in the technical specifications.

Any other use than that described in this document is regarded as improper.

3. Function

3.1 Device features

- Undervoltage and overvoltage monitoring in 3(N)AC systems
- Preset function: Automatic response value setting for undervoltage and overvoltage, $< U$ and $> U$ as well as for underfrequency and overfrequency $< f$ and $> f$
- Voltage and frequency monitoring with window discriminator function, $< U$ and $> U$ as well as $< f$ and $> f$
- Monitoring of asymmetry, phase failure and phase sequence
- Indication of the system frequency f
- Start-up delay, response delay, delay on release
- Adjustable switching hysteresis for U and f
- Frequency alarm behaviour in case of measuring voltage failure can be parameterised
- r.m.s. value measurement AC + DC
- Digital measured value display via multi-functional LC display
- Alarm indication via LEDs (AL1, AL2) and changeover contacts (K1, K2)
- N/C operation or N/O operation selectable
- Password protection to prevent unauthorised parameter changes
- Selectable fault memory behaviour. In "con" mode, all alarm parameters remain stored in case of failure of the nominal voltage ($U_n = U_s$)
- Start-up of the device optionally with or without simulated alarm message

3.2 Functional description

Once the nominal voltage is applied, the start-up delay " t " begins. Measured values changing during this time do not influence the switching state of the alarm relays.

The devices provide two separately adjustable measuring channels (overvoltage/undervoltage). If the measured value exceeds the response value (alarm 1) or falls below the response value (alarm 2), the set response delays " $t_{on1/2}$ " start. Once the response delay has elapsed, the alarm relays switch and the alarm LEDs light up. If the measured value falls below or exceeds the release value (response value plus hysteresis) after the alarm relays have switched, the pre-defined delay on release " t_{off} " starts. Once " t_{off} " has elapsed, the alarm relays switch back to their initial position. If the fault memory is enabled, the alarm relays remain in alarm state until the reset button R is pressed. Even in case of complete power failure of the system being monitored, the delay times are effective during the energy backup discharging time.

3.3 Fast commissioning for $U_n = 400\text{ V}$, 50 Hz

If you are already familiar with voltage monitors, you can reduce the time for commissioning and connection using this brief description.

1. Check that the three-phase system being monitored is operated with a nominal voltage of $U_n = 400\text{ V}$ and 50 Hz. This is the precondition for an automatic setting of the response values (preset after the first connection to the nominal voltage).
2. Make sure that the voltage monitor is in the delivery state (factory settings have not been changed).
3. When conditions 1 and 2 are fulfilled, connect the voltage monitor to the three-phase system to be monitored according to the wiring diagram (page 19). The following pre-defined response values will be set automatically:

VMD421H			
U_n, f_n	Preset operating range	Response value < U, < f	Response value > U, > f
400 V (L1, L2, L3)	340 V...440 V	340 V	440 V
50 Hz	47...53 Hz	49 Hz	51 Hz

The currently measured phase voltage between L1 and L2 appears on the display. Use the Up and Down buttons to query other parameters:

- Phase-to-phase voltage L2, L3
- Phase-to-phase voltage L1, L3
- Asymmetry
- System frequency
- Phase sequence

For detailed information about the preset function and other voltage ranges, refer to page 13, page 37 provides a summary of all factory settings.

To reset the voltage monitor to the factory settings, if necessary, refer to the instructions on page 35.

3.4 Preset function

After connecting the system to be monitored for the first time, the response values for overvoltage and undervoltage (alarm 1/2) are automatically set once to the following values:

Response value overvoltage ($> U$): $1.1 U_n$

Response value undervoltage ($< U$): $0.85 U_n$

Response value overfrequency ($> f$) at 16.7 Hz, 50 Hz, 60 Hz: $f_n + 1$ Hz

Response value overfrequency ($> f$) at 400 Hz: $f_n + 1$ Hz

Response value underfrequency ($< f$) at 16.7 Hz, 50 Hz, 60 Hz: $f_n - 1$ Hz

Response value underfrequency ($< f$) at 400 Hz: $f_n - 1$ Hz

Preset VMD421H				
Measuring principle	U_n	Preset operating range	Response value $< U$	Response value $> U$
Three-phase measurement: 3Ph	400 V (L1, L2, L3)	340...440 V	340 V	440 V
	208 V (L1, L2, L3)	177...229 V	177 V	229 V
The following response values are only set by manually starting the preset function (Menu/SEt/PrE)				
Three-phase-N measurement: 3n	230 V (L1, L2, L3, N)	196...253 V	196 V	253 V
	120 V (L1, L2, L3, N)	102...132 V	102 V	132 V

If the measured voltage is not within the preset operating range listed in the table, the message "AL not Set" appears on the display. Therefore it is necessary to set the response values for alarm 1 (AL1) and alarm 2 (AL2) manually. A detailed description of the process is given in the chapter "Parameter setting".

After restoring the factory settings, the preset function is automatically active again.

During operation, the preset function can be started manually via the SEt menu.

3.5 Automatic self test

The device automatically carries out a self test after connection to the system to be monitored and later every hour. During the self test internal malfunctions are detected and shown as an error code on the display. The alarm relays are not switched during this test.

3.6 Manual self test

The device runs a self test after the test button is pressed for > 1.5 s. Any internal malfunctions detected during this test are shown as an error code on the display. The alarm relays are not switched during this test.

While pressing and holding the test button T, all device-relevant display elements appear on the display.

3.7 Malfunction

In the event of an internal malfunction, all three LEDs flash. The display shows an error code (E01...E32). In such a case please contact the Bender Service.

3.8 Fault memory

The fault memory can be enabled, disabled or set to continuous mode (con). If the fault memory is set to "con" mode, a stored alarm remains stored even after failure of the nominal voltage ($U_n = U_s$), also after the energy backup discharging time has elapsed.

3.9 Assigning alarms to alarm relays K1/K2

Different alarm categories can be assigned to the alarm relays K1/K2 via the "out" menu.

3.10 Delay times t , t_{on} and t_{off}

The times t , t_{on} and t_{off} described below delay the output of alarms via LEDs and relays.

Start-up delay t

Once the voltage U_n to be monitored has been connected, the alarm indication is delayed by the preset time t (0...300 s).

Response delay t_{on}

When the value falls below or exceeds the response value, the voltage monitor requires the response time t_{an} until the alarm is activated.

A preset response delay t_{on} (0...300 s) adds up to the device-related operating time t_{ae} and delays alarm signalling (total delay time $t_{an} = t_{ae} + t_{on}$).

Should the fault no longer persist during the response delay, the alarm signal drops out.

Delay on release t_{off}

If the alarm no longer exists during the response delay and the fault memory is disabled, the alarm LEDs goes out and the alarm relays switch back to their initial position. The alarm state is continuously maintained for the selected period by activating the delay on release (0...99 s).

3.11 Password protection (on, OFF)

If password protection has been enabled (on), settings can only be made subject to the correct password being entered (0...999). If you cannot operate your device because you cannot remember your password, please contact info@bender-service.com.

3.12 Factory settings FAC

After restoring the factory settings, all settings previously changed are reset to the state upon delivery. In addition, the preset function allows automatic adaptation of the response values in relation to the nominal voltage U_n .

3.13 Erasable history memory

The first alarm value that occurs is stored in this memory. Subsequent alarms do not overwrite this "old" value. The memory can be cleared using the Clr button in the HiS menu.

3.14 Alarm LEDs show which relay is in the alarm state

When the menu item **LEd**  is activated, the alarm LED AL1 indicates that K1 is in the alarm state. When AL2 lights up, K2 is in the alarm state. An alarm relay can only switch to the alarm state if an alarm category has been assigned to it.

When the menu item **LEd**  is deactivated, AL1 signals overvoltage, AL2 signals undervoltage, both LEDs AL1 and AL2 light up in case of frequency alarm.

For details about alarm category assignment to the respective relays, refer to the sub-menu "out" description on page 23.

3.15 Starting the device with a simulated alarm S.AL

If the menu item S.AL has been activated in the out menu, K1 or K2 switches back to the alarm state once the nominal voltage is applied. This state is maintained for the delay time $t + t_{on1}$. Once this time has elapsed, K1 or K2 switches back to the initial position provided that no fault is detected at the measuring input.

The following diagrams show the effect of a fault during a simulated alarm.

Faults at the measuring input and the resulting condition of the alarm relay K1 (K2) are shown as a hatched area.

The fault shown below as an example for K1 starts during the S.AL phase:

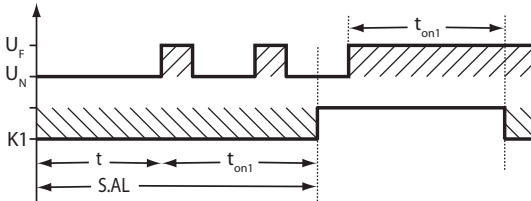

The fault shown below as an example for K1 starts after the S.AL phase:

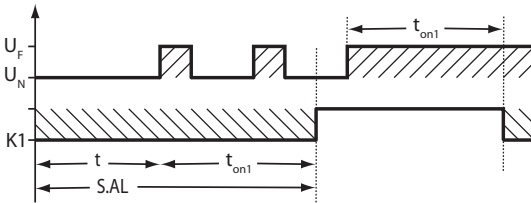

3.16 Frequency alarm in case of measuring voltage failure

(Menu -> AL -> <U Hz)

If the voltage of the monitored system falls to the point where the frequency can no longer be determined, this parameter is used to set how the frequency alarm should behave.

On: The device sets the underfrequency/and overfrequency alarm (factory setting).

Off: The device does not set a frequency alarm.

Note for <U Hz = Off:



If there are transients (depending on circuit breakers and system parameters) when the voltage of the monitored system fails or returns, the device may still briefly output a frequency alarm. To avoid this behaviour, the relay to which frequency alarms are assigned must be delayed by means of t_{on1} or t_{on2} and t_{off} .



If the frequency of the monitored system slowly returns (e.g. due to a starting generator), the frequency monitoring only becomes active again when the frequency is within specified limits (≥ 10 Hz).

4. Installation and connection



Only **qualified personnel** are permitted to carry out the work necessary to install, commission and run a device or system.



DANGER

Risk of fatal injury due to electric shock!

Touching live parts of the system carries the risk of:

- An electric shock
- Damage to the electrical installation
- Destruction of the device

Before installing the device and before working on the connections of the device, make **sure** that the system is **de-energised**. The rules for working on electrical systems must be observed.

General dimension diagram and drawing for screw fixing

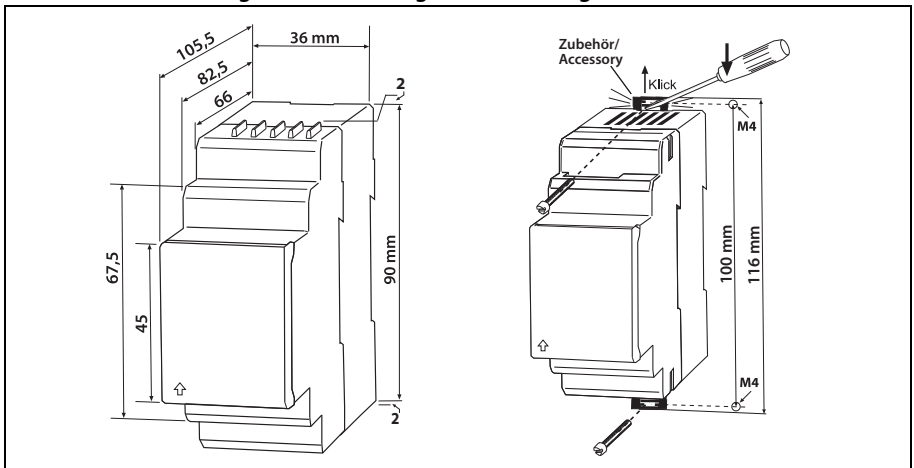

Mount the device vertically to allow sufficient air flow through the ventilation slots at top and bottom!

The front plate cover can be opened at the lower part marked with an arrow.

DIN rail mounting: Snap the rear mounting clip of the device into place in such a way that a safe and tight fit is ensured.

Screw mounting: Use a tool to position the rear mounting clips (a second mounting clip is required, see ordering information) so that they project beyond the enclosure. Then fix the device using two M4 screws.

5. Wiring

Connect the device according to the wiring diagram.

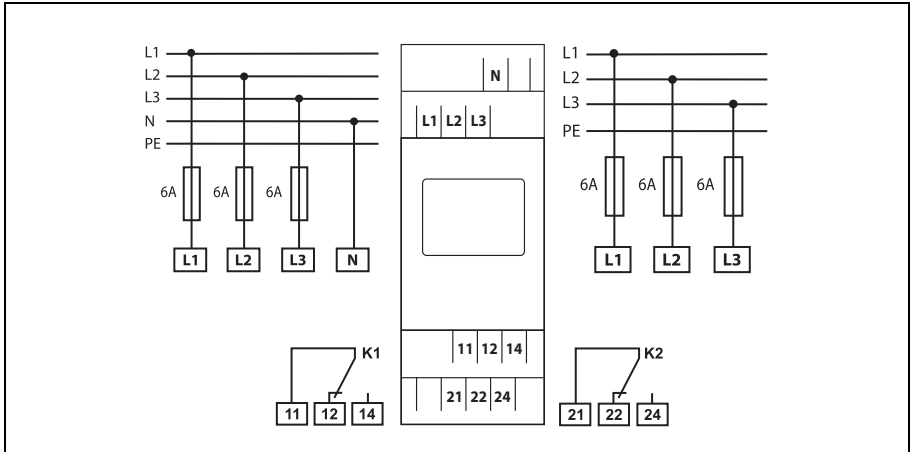

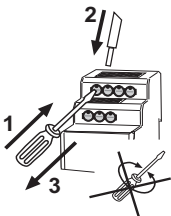

	Terminal	Connections
	L1, L2, L3, (N)	Connection to the system to be monitored
	11, 12, 14	Alarm relay K1
	21, 22, 24	Alarm relay K2





6. Operation and settings

6.1 Display elements in use

The meaning of the display elements in use is listed in the table below.

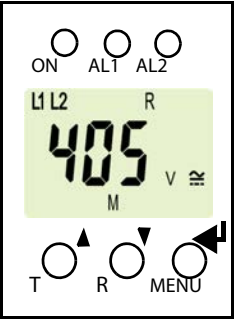

Display elements in use	Element	Function
	L1...L3N	Conductor L1...L3 (phase), neutral conductor
	Asy, %	Asymmetry in %
	< U, > U	Undervoltage (alarm 2), Overvoltage (alarm 1)
	r1, 1 r2, 2	Alarm relay K1, Alarm relay K2
	R, L	Phase sequence clockwise, phase sequence counter-clockwise (L = l.)
	U Hys, %	Response value hysteresis in %
	< Hz, > Hz	Underfrequency (AL1 and AL2) Overfrequency (AL1 and AL2)
	Hz Hys	Frequency response value hysteresis in Hz
	<U Hz	Frequency alarm in case of measuring voltage failure
	ton1, ton2, t, toff	Response delay t_{on1} (K1), Response delay t_{on2} (K2) Start-up delay t , Delay on release t_{off} for K1, K2
	M	Fault memory enabled
		Operating mode of relays K1, K2; or LEDs AL1/AL2 indicate the alarm state of K1/K2
		Password protection enabled

6.2 Function of the operating elements

User interface	Element	Function
	ON	Power On LED, green
	AL1, AL2	Menu item LEd  deactivated: LED alarm 1 lights (yellow): response value > U exceeded LED alarm 2 lights (yellow): below response value < U
	AL1 and AL2	Menu item LEd  deactivated: Both LEDs light when the frequency response values < Hz or > Hz are reached
	AL1, AL2	Menu item LEd  activated: LED alarm 1 lights (yellow): K1 signals an arbitrary alarm LED alarm 2 lights (yellow): K2 signals an arbitrary alarm
	405 V, R, M	$U_n = 405$ V between L1 and L2, phase sequence clockwise, fault memory enabled
	T, ▲	Test button (> 1.5 s): indicate display elements available for this device, start a self test; Arrow-up button (< 1.5 s): menu items/values
	R, ▼	Reset button (> 1.5 s): clear fault memory; Arrow-down button (< 1.5 s): menu items/values
	User interface	Element
	MENU, ◀	MENU button (> 1.5 s): start menu mode; Enter button (< 1.5 s): confirm menu item, submenu item and value. Enter button (> 1.5 s): back to the next higher menu level.

6.3 Menu structure

All adjustable parameters are listed in the columns Menu item and Adjustable parameter. A display-like representation is used to illustrate the parameters in the column Menu item. Different alarm categories can be assigned to the alarm relays K1, K2 via the submenus r1, r2. This is done by activating or deactivating the respective function.

Menu	Sub menu	Menu item	Activation	Adjustable parameter	
AL (response values)	→	< U	ON	Undervoltage (alarm 2)	
		> U	ON	Overvoltage (alarm 1)	
		U Hys	-	Hysteresis < U / > U	
		Asy	-	Asymmetry alarm	
		< Hz	OFF	Underfrequency	
		> Hz	OFF	Overfrequency	
		Hz Hys	-	Hysteresis, Frequency	
		< U Hz	ON	Frequency alarm in case of measuring voltage failure (< U Hz)	
		PHS	OFF	Phase sequence R / L	
out (output control)	→	M	ON	Fault memory (on, con, off)	
		 1	-	Operating mode K1 (n.o.)	
		 2	-	Operating mode K2 (n.c.)	
		 LED	OFF	LEDs signal relay in alarm state	
	r1 (K1: alarm category assignment)		1 Err	OFF	Device error at K1
			r1 < U	OFF	Undervoltage at K1
			r1 > U	ON	Overvoltage at K1
			r1 Asy	ON	Asymmetry alarm at K1
			r1 < Hz	ON	Underfrequency alarm at K1
			r1 > Hz	ON	Overfrequency alarm at K1
			1 PHS	ON	Phase sequence alarm at K1
			1 S.AL	OFF	Start with alarm during t + ton1
	r2 (K2: alarm category assignment)		2 Err	OFF	Device error at K2
			r2 < U	ON	Undervoltage at K2
			r2 > U	OFF	Overvoltage at K2
			r2 Asy	ON	Asymmetry alarm at K2
			r2 < Hz	ON	Underfrequency alarm at K2
			r1 > Hz	ON	Overfrequency alarm at K1
			2 PHS	ON	Phase sequence alarm at K2
			2 S.AL	OFF	Start with alarm during t + ton2

Menu	Sub menu	Menu item	Activation	Adjustable parameter
t (timing control)	→	t on 1	-	Response delay K1
		t on 2	-	Response delay K2
		t	-	Start-up delay
		t off	-	Delay on release K1/K2
Set (device control)	→	L1L2L3	-	Measuring principle: phase-to-phase voltage 3Ph, phase-to-neutral voltage 3n
			OFF	Set parameters via password
		FAC	-	Restore factory settings
		PrE	-	Manual preset
		SYS	-	Function locked
InF	→		-	Display hardware/software version
HiS	→	Clr	-	History memory for the first alarm value, erasable

6.4 Display in standard mode

By default, the display shows the phase-to-phase voltage between L1 and L2. By pressing the Up or Down button, details regarding asymmetry, system frequency and phase sequence are displayed, amongst others. In order to change the default display, confirm your choice with Enter.

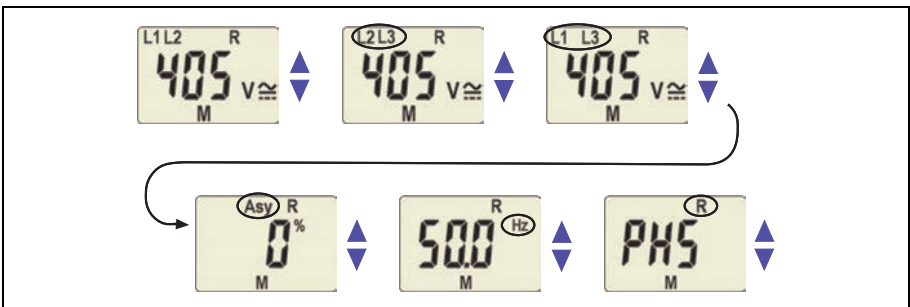

In the standard mode, the currently measured voltages as well as asymmetry, system frequency and phase sequence can be displayed using the Up and Down buttons.

6.5 Display in menu mode

6.5.1 Parameter query and setting: overview

Menu item	Adjustable parameter
AL	Query and set response values: <ul style="list-style-type: none"> – Undervoltage: < U (AL2) – Overvoltage: > U (AL1) – Hysteresis of the voltage response values: Hys U – Asymmetry: Asy (AL1 and AL2) – Underfrequency: < Hz (AL1 and AL2) – Overfrequency: > Hz (AL1 and AL2) – Hysteresis of the frequency response values: Hys Hz – Frequency alarm in case of measuring voltage failure: <U Hz – Phase sequence: PHS (AL1 and AL2)
out	Configure fault memory and alarm relays: <ul style="list-style-type: none"> – Enable/Disable fault memory or set con mode – Select N/O operation (n.o.) or N/C operation (n.c.) individually for K1/K2 – Assign the alarm categories undercurrent, overcurrent, underfrequency, overfrequency or device error individually to K1/K2 (1, r1 / 2, r2) – AL1/AL2 indicate that K1/K2 are in alarm state (LEd)
t	Set delays: <ul style="list-style-type: none"> – Response delay t_{on1}/t_{on2} – Start-up delay t – Delay on release t_{off} (LED, relay)
SEt	Set parameters for device control <ul style="list-style-type: none"> – Select measurement method 3Ph or 3n – Enable or disable password protection, change password – Restore factory settings – Start preset function PrE manually – Service menu SyS locked
InF	Query hardware and software version
HiS	Query the alarm value saved first
ESC	Move to the next higher menu level (back)

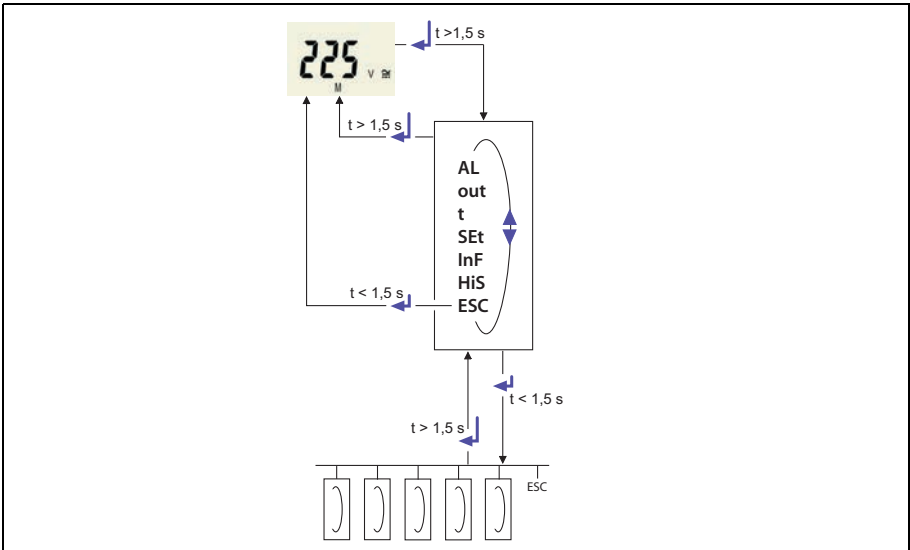

Parameter setting

An example is given below on how to change the alarm response value for overvoltage > U. Proceed as follows:

1. Press the MENU/Enter button for more than 1.5 seconds. The flashing short symbol AL appears on the display.
2. Confirm with Enter. The parameter undervoltage < U flashes.
3. Press the Down button to select the parameter overvoltage > U. The parameter > U flashes.
4. Confirm with Enter. "on" flashes to indicate that the response value > U is being activated.
5. Confirm the activation with Enter. The corresponding value in V flashes.
6. Use the Up or Down button to set the appropriate response value. Confirm with Enter. > U flashes.
7. You can exit the menu by:
 - Pressing the Enter button for more than 1.5 seconds to reach the next higher level
 - Selecting the menu item ESC and confirming with Enter to reach the next higher level.



The areas of the display that can be configured flash! This is indicated by an oval in the illustrations below. Press and hold down the MENU button > 1.5 s to enter menu mode.

6.5.2 Setting the response values for undervoltage and overvoltage

- Value of the undervoltage ($< U$)
- Value of the overvoltage ($> U$)
- Hysteresis (Hys) of the response values $< U$ and $> U$
- Asymmetry (Asy) of the phases
- Phase sequence (PHS) counter-clockwise (L) or clockwise (R), in the example below from R to L

Setting the response value for undervoltage $< U$

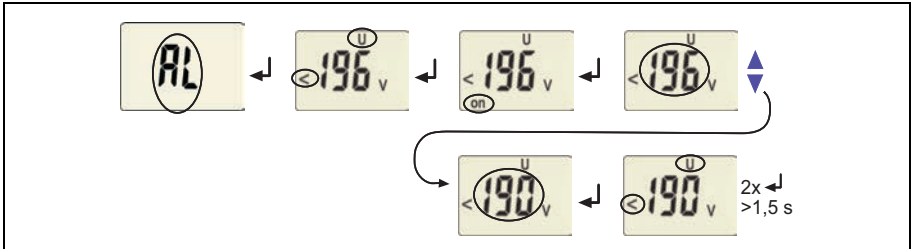

Setting the response value for overvoltage $> U$

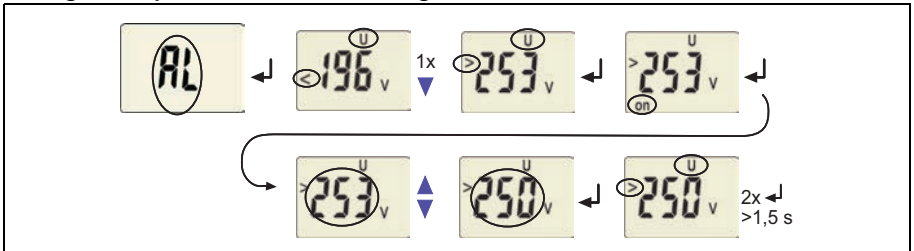

Setting the hysteresis of the voltage response values

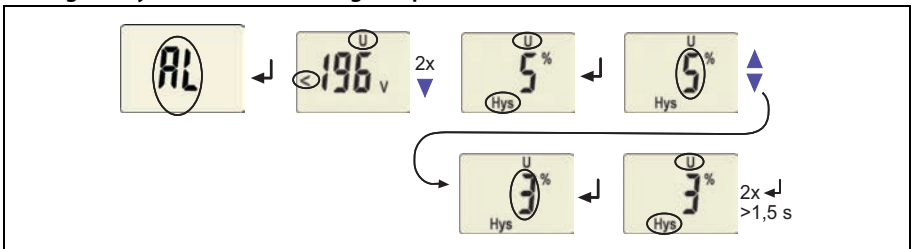

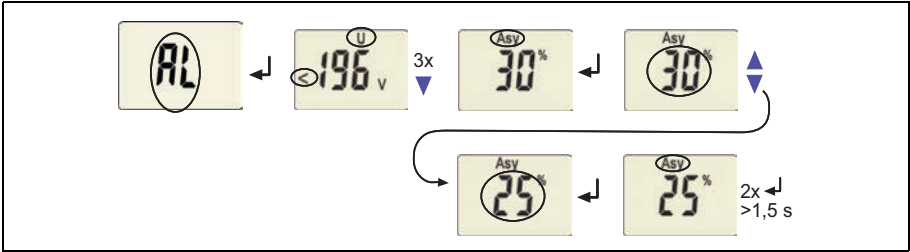
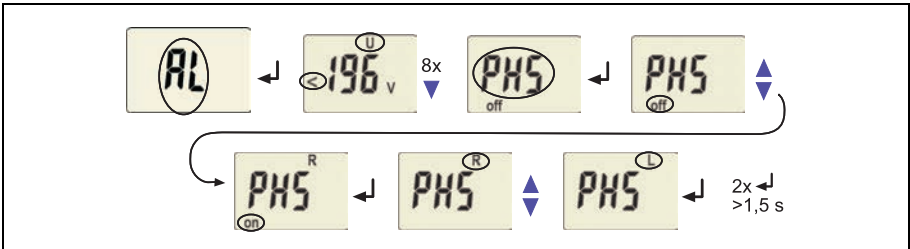
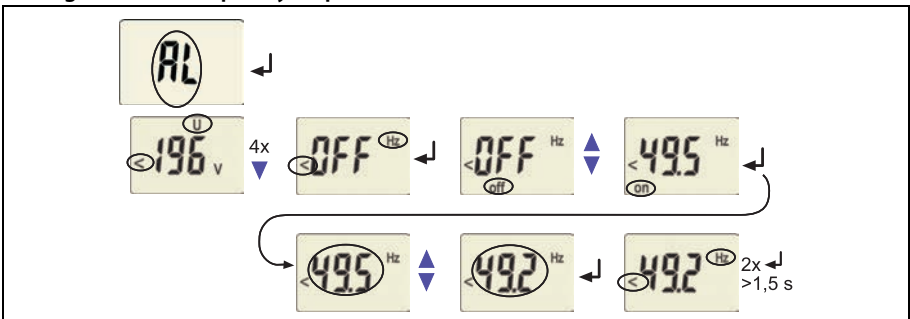
Setting the asymmetry response value

Setting the phase sequence response value

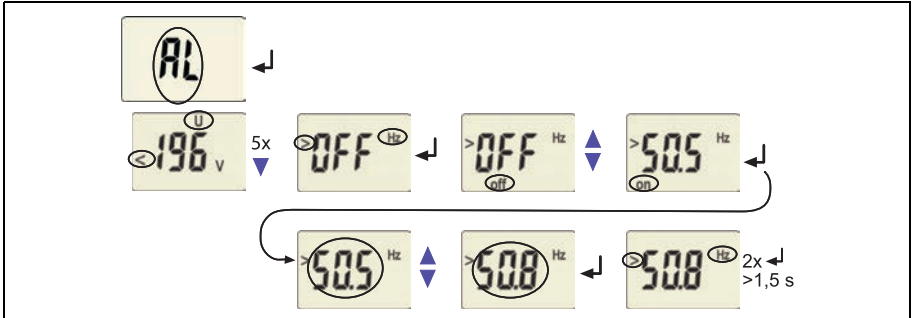
6.5.3 Setting the response values for underfrequency, overfrequency and hysteresis
Setting the underfrequency response value < Hz

Setting the overfrequency response value > Hz

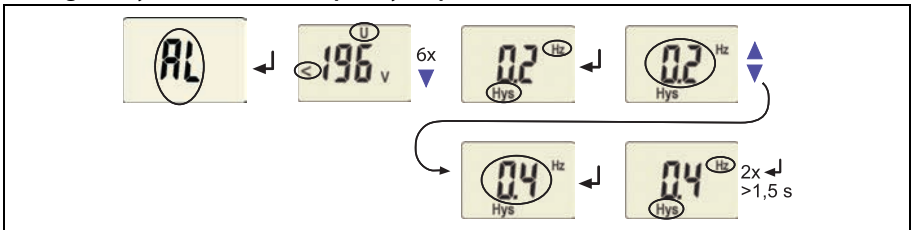

Setting the hysteresis of the frequency response values



Deactivating the frequency alarm in case of a measuring voltage failure

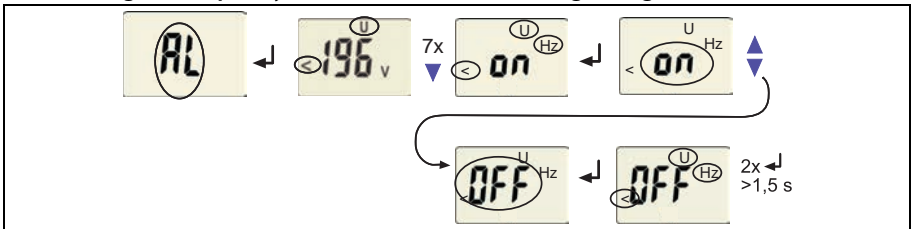

6.5.4 Setting the fault memory and operating mode of the alarm relays

Disabling the fault memory

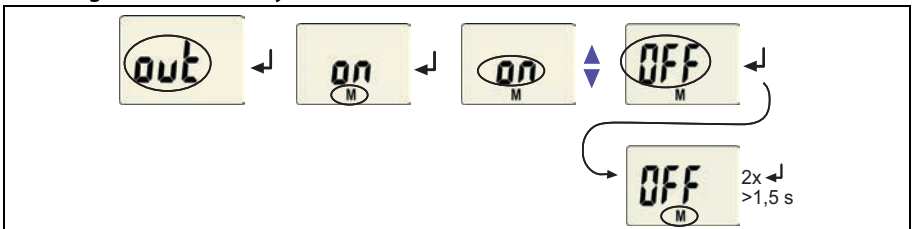

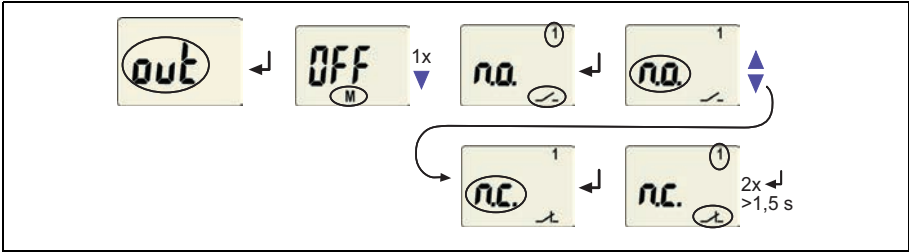
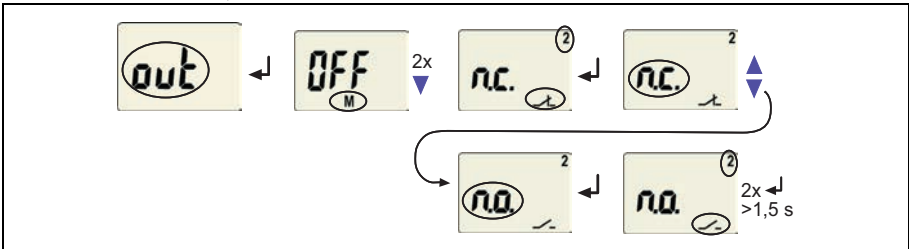
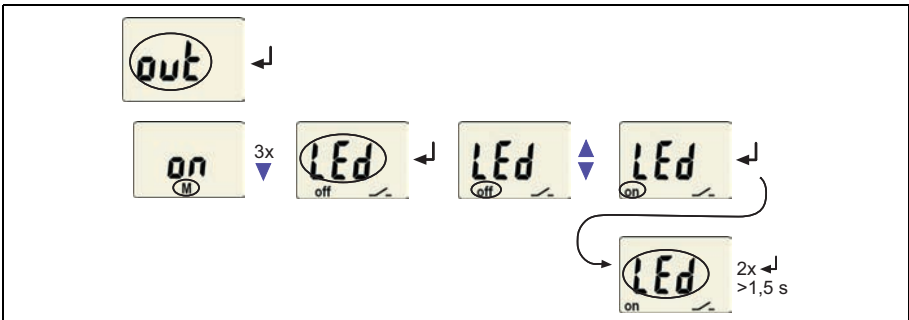
Setting the alarm relay K1 to N/C operation (n.c.)

Setting the alarm relay K2 to N/O operation (n.o.)

LEDs AL1/AL2 are intended to indicate the alarm state of K1/K2

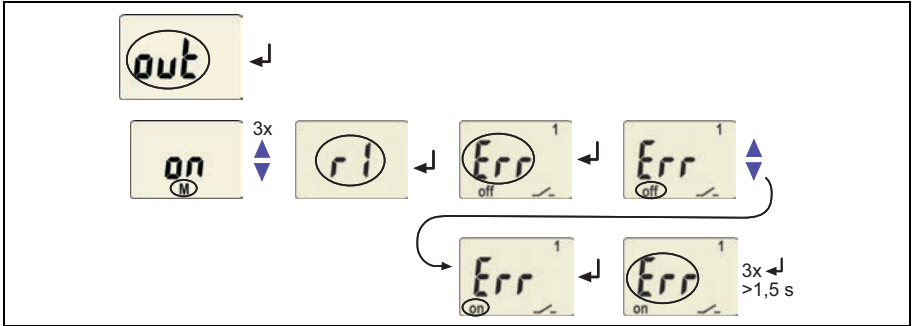
6.5.5 Assigning alarm categories to the alarm relays

Undervoltage, overvoltage, underfrequency, overfrequency, asymmetry, phase sequence and device-related error messages of the voltage monitor can be assigned to the alarm relays K1 (r1, 1) and K2 (r2, 2). K1 is factory-set to signal an alarm in case of overvoltage, and K2 is set to signal an alarm in case of undervoltage. A few assignment examples for alarm relay K1 are illustrated below.

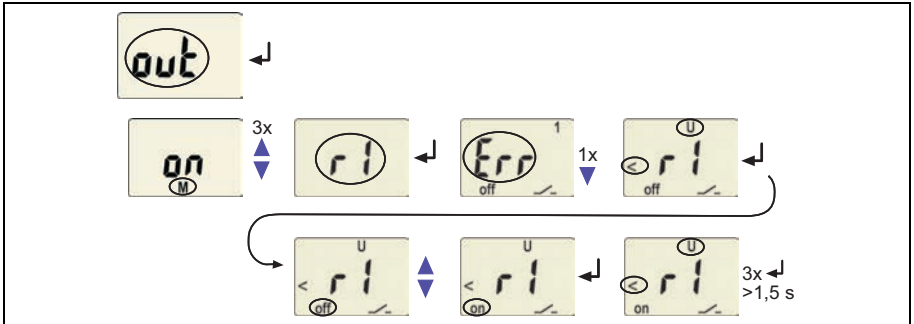
Alarm relay K1: assigning the category device error



Alarm relay K1: assigning the category undervoltage



Alarm relay K1: deactivating the category overvoltage

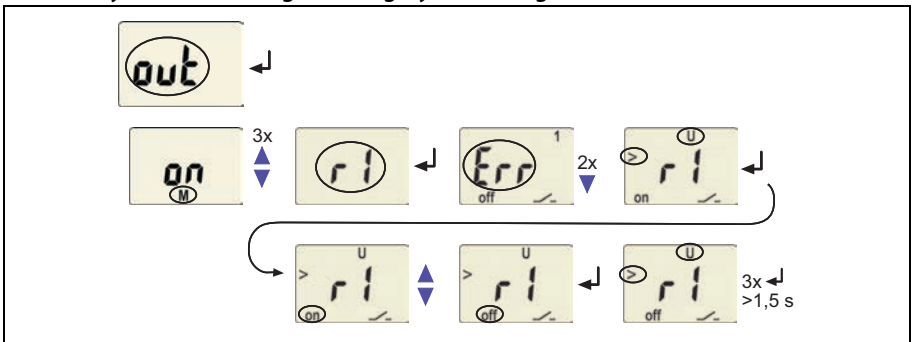

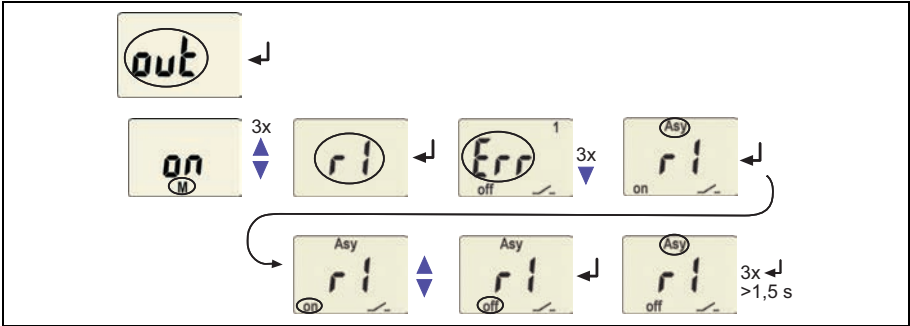
Alarm relay K1: deactivating the category asymmetry alarm

CAUTION

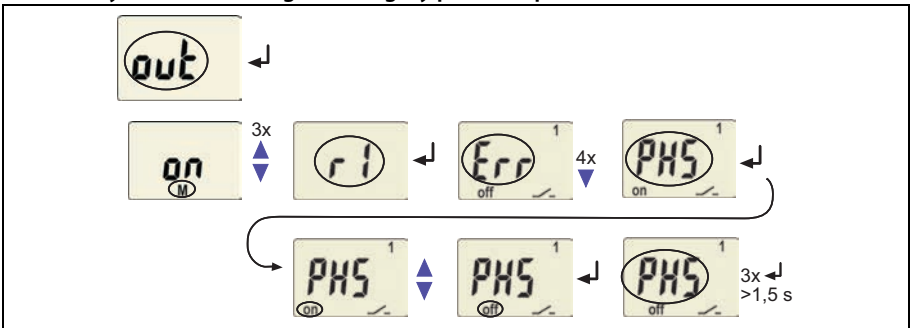
Deactivating an alarm relay K1/K2) via the menu prevents an alarm being indicated by the respective changeover contact!
 An alarm will only be indicated by the respective alarm LED (AL1/AL2)!
 This only applies to the out menu setting LE_d = off!

Alarm relay K1: Deactivating the category phase sequence alarm

6.5.6 Setting delay times

The following delays can be set:

- Response delay t_{on1} (0...300 s) for K1, as well as t_{on2} (0...300 s) for K2
- Start-up delay t (0...300 s) during device start
- Common delay on release t_{off} (0...300 s) for K1, K2. The setting t_{off} is only relevant when the fault memory M is disabled.

The operating steps for the setting of the response delay t_{on1} and the start-up delay t are illustrated by way of example.

Setting the response delay t_{on1}

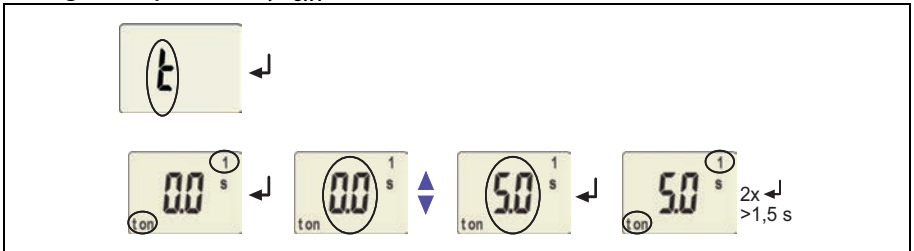

Setting the start-up delay t

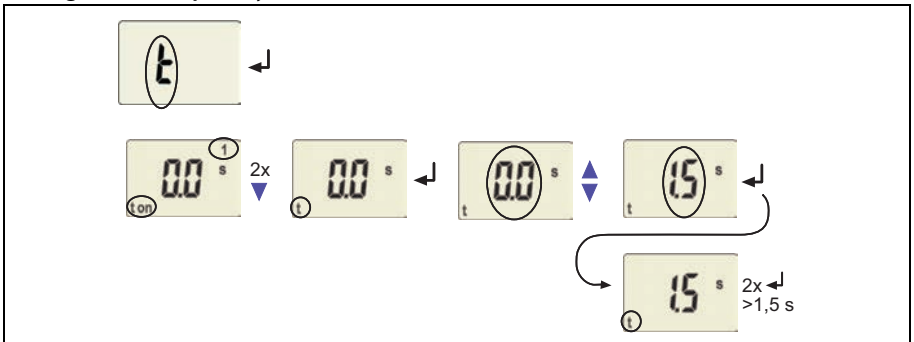

6.5.7 Select measurement method

Use this menu item to select between phase to N (3n) or phase-to-phase (3Ph) measurement. If the device has been connected to the neutral conductor and the phase conductors, the measurement method can be freely selected.

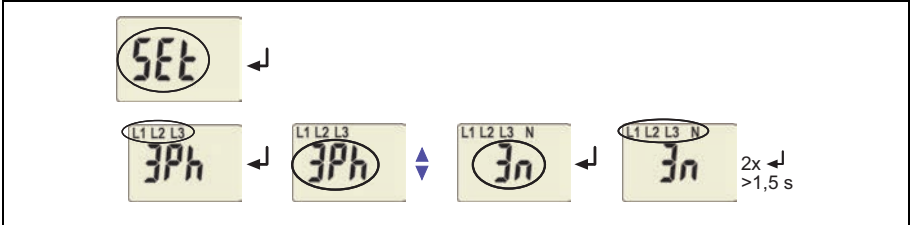

6.5.8 Factory setting and password protection

This menu can be used to enable the password protection, modify the password or to disable the password protection. It is also where the device can be reset to the factory settings.

a) Enabling the password protection

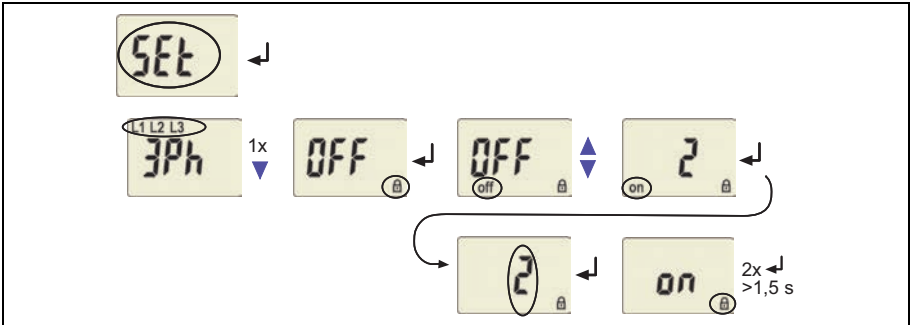

b) Changing the password

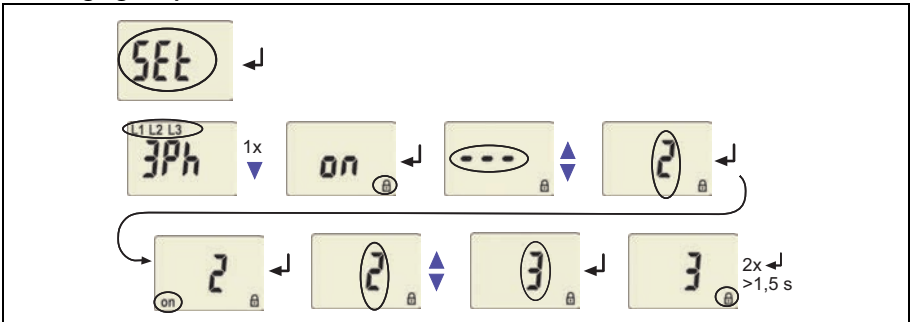

c) Disabling the password protection

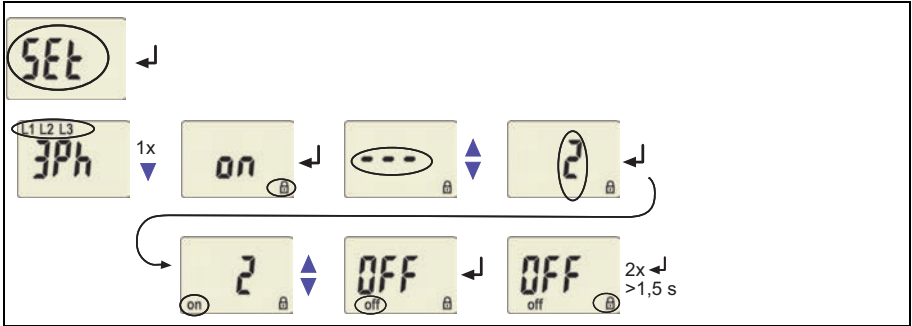

6.5.9 Restoring factory settings

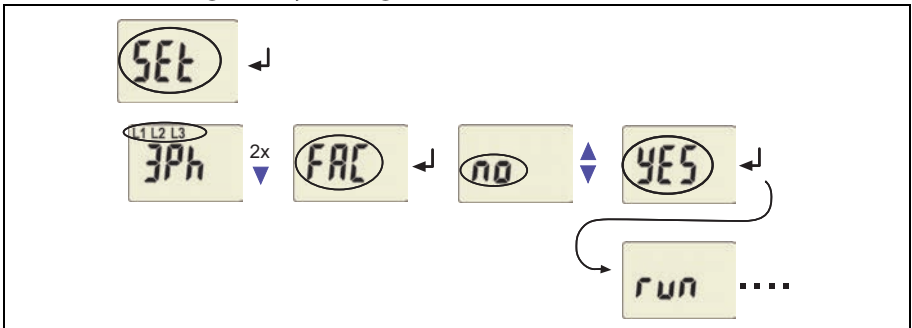

6.5.10 Manual activation of the preset function

During the operating process, the measuring principle is queried. Select either three-phase-N measurement (3n) or three-phase measurement (3Ph). In the example below, three-phase measurement has been selected.

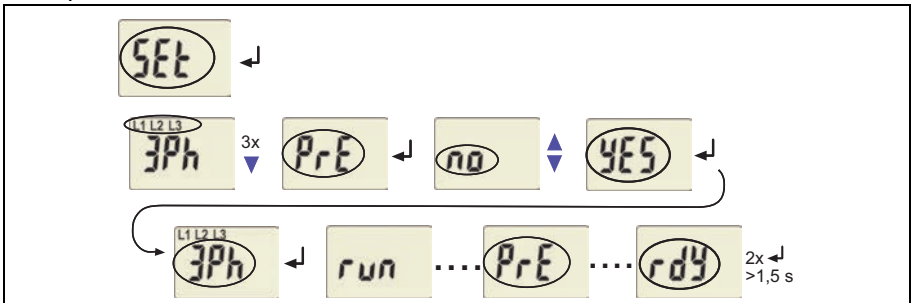

6.5.11 Querying device information

This function is used to query the software (1.xx) version. After activating this function, data will be displayed as a scrolling text. Once the routine has been run through, individual data sections can be selected using the Up/Down buttons.

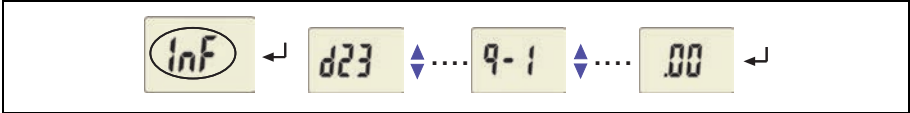

6.5.12 Querying the history memory

Select the history memory via the menu HiS. Use the Up and Down buttons to view the next display. If Clr is flashing, the history memory can be cleared by pressing the Enter button.

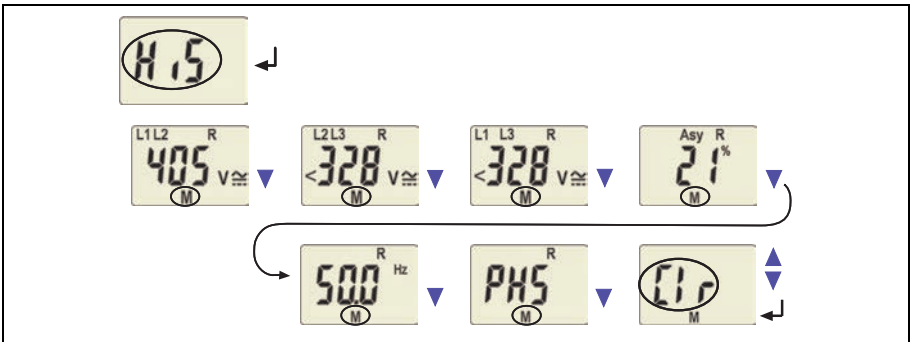

6.6 Commissioning

Prior to commissioning, check that the voltage monitor is connected properly.



After connecting a brand-new VMD421H to a standard system of $U_n = 400\text{ V}$, 50 Hz , the response values are automatically set by the internal preset function:
 Overvoltage = 440 V ($400\text{ V} + 10\%$) ($50\text{ Hz} + 1\text{ Hz}$)
 Undervoltage = 340 V ($400\text{ V} - 15\%$) ($50\text{ Hz} - 1\text{ Hz}$)
 Other operating ranges of the preset function are given in the technical data under response values and in the functional description.

6.7 Preset function/Factory settings

During initial commissioning, predefined response values are set automatically depending on U_n :

Response value overvoltage ($> U$): $1.1 U_n$

Response value undervoltage ($< U$): $0.85 U_n$



<i>Hysteresis U</i>	5 %
<i>Underfrequency < Hz</i>	OFF
<i>Overfrequency > Hz</i>	OFF
<i>Hysteresis frequency (Hys Hz)</i>	0.2 Hz
<i>Frequency alarm in case of measuring voltage failure (< U Hz)</i>	on
<i>Fault memory M</i>	on
<i>Operating principle K1 (> U, Asy)</i>	N/O operation (n.o.), N/C operation (n.c.)
<i>Operating principle K2 (< U, Asy)</i>	OFF
<i>AL1/AL2 indicate the alarm state of K1/K2 (LEd)</i>	OFF
<i>Alarm during device start at K1/K2 (S.AL)</i>	30 %
<i>Asymmetry</i>	OFF
<i>Phase sequence monitoring</i>	$t = 0 s$
<i>Start-up delay</i>	$t_{on1} = 0 s$
<i>Response delay</i>	$t_{on2} = 0 s$ $t_{off} = 0.5 s$
<i>Delay on release</i>	3Ph (phase conductor measurement)
<i>Measurement method</i>	0, Off
<i>Password</i>	

7. Technical data VMD421H

7.1 Tabular data

()* = Factory setting

Insulation coordination acc. to IEC 60664-1/IEC 60664-3

Rated voltage	400 V
Rated impulse voltage/Pollution degree	4 kV / III
Protective separation (reinforced insulation) between.....	(N, L1, L2, L3) - (11, 12, 14) - (21, 22, 24)
Voltage test according to IEC 61010-1:	
(N, L1, L2, L3) - (11, 12, 14)	3.32 kV
(N, L1, L2, L3) - (21, 22, 24)	2.21 kV

Supply voltage

Supply voltage U_s	none (internal supply from U_n)
Power consumption	≤ 6 VA

Measuring circuit

Measuring range (r.m.s. value) (L-N)	AC 0...288 V
Measuring range (r.m.s. value) (L-L)	AC 0...500 V
Rated frequency f_n	15...460 Hz
Frequency range	10...500 Hz

Response values

System type	3(N) AC / 3 AC (3 AC)*
Undervoltage < U (alarm 2) (measurement method: 3Ph / 3n)	AC 70...500 V / 70...288 V
Overvoltage > U (alarm 1) (measurement method: 3Ph / 3n)	AC 70...500 V / 70...288 V
Resolution of setting U	1 V
Preset function for 3 AC measurement:	
Undervoltage < U (0.85 U_n)* for $U_n = 400$ V / 208 V	340 V / 177 V
Overvoltage > U (1.1 U_n)* for $U_n = 400$ V / 208 V	440 V / 229 V
Preset function for 3(N)AC measurement:	
Undervoltage < U (0.85 U_n)* for $U_n = 230$ V / 120 V	196 V / 102 V
Overvoltage > U (1.1 U_n)* for $U_n = 230$ V / 120 V	253 V / 132 V
Hysteresis U	1...40 % (5 %)*
Asymmetry	5...30 % (30 %)*
Phase failure	by setting the asymmetry
Phase sequence	clockwise/counter-clockwise (off)*
Relative percentage error, voltage at 50 Hz / 60 Hz	± 1.5 %, ± 2 digits
Relative percentage error in the voltage range of 15 Hz...460 Hz	± 3 %, ± 2 digits

Underfrequency < Hz	10... 500 Hz**
Overfrequency > Hz	10... 500 Hz**
Resolution of setting f 10.0... 99.9 Hz	0.1 Hz
Resolution of setting f 100... 500 Hz	1 Hz
Preset function:	
Underfrequency for $f_n = 16.7$ Hz / 50 Hz / 60 Hz / 400 Hz	15.7 Hz / 49 Hz / 59 Hz / 399 Hz
Overfrequency for $f_n = 16.7$ Hz / 50 Hz / 60 Hz / 400 Hz	17.7 Hz / 51 Hz / 61 Hz / 401 Hz
Hysteresis frequency Hys Hz	0.1... 2 Hz (0.2 Hz)*
Relative percentage error in the frequency range of 15... 460 Hz	± 0.2 %, ± 1 digit

Time response

Start-up delay t	0... 300 s (0 s)*
Response delay $t_{on1/2}$	0... 300 s (0 s)*
Delay on release t_{off}	0... 300 s (0.5 s)*
Resolution of setting $t, t_{on1/2}, t_{off}$ (0... 10 s)	0.1 s
Resolution of setting $t, t_{on1/2}, t_{off}$ (10... 99 s)	1 s
Resolution of setting $t, t_{on1/2}, t_{off}$ (100... 300 s)	10 s
Operating time, voltage t_{ae}	≤ 140 ms
Operating time, frequency t_{ae}	≤ 335 ms
Response time t_{an}	$t_{an} = t_{ae} + t_{on1/2}$
Discharging time energy backup on power failure	≥ 2.5 s
Charging time energy backup	≤ 60 s
Recovery time t_b	≤ 300 ms

Displays, memory

Display	LC display, multi-functional, not illuminated
Display range measured value	AC/DC 0... 500 V
Operating error, voltage at 50 Hz / 60 Hz	± 1.5 %, ± 2 digits
Operating error in the voltage range of 15... 460 Hz	± 3 %, ± 2 digits
Operating error in the frequency range of 15... 460 Hz	± 0.2 %, ± 1 digits
History memory (HiS) for the first alarm value	data record measured values
Password	Off / 0... 999 (OFF)*
Fault memory (M) alarm relay	on / off / con (on)*

Switching elements

Number of changeover contacts	2 x 1 (K1, K2)
Operating principle	N/C operation / N/O operation
..... K2: Err, < U, > U, Asy, < Hz, > Hz, PHS, S.AL (undervoltage < U, asymmetry Asy, N/C operation)*	
..... K1: Err, < U, > U, Asy, < Hz, > Hz, PHS, S.AL (overvoltage > U, asymmetry Asy, N/O operation)*	
Electrical endurance under rated operating conditions, number of cycles	10 000

Contact data acc. to IEC 60947-5-1:

Utilisation category	AC 13	AC 14	DC-12	DC-12	DC-12
Rated operational voltage	230 V	230 V	24 V	110 V	220 V
Rated operational current	5 A	3 A	1 A	0.2 A	0.1 A
Minimum contact rating.....	1 mA at AC/DC ≥ 10 V				

Environment/EMC

EMC	IEC 61326
Operating temperature	-25 °C ... +55 °C
Classification of climatic conditions acc. to IEC 60721:	
Stationary use (IEC 60721-3-3)	3K23 (except condensation and formation of ice)
Transport (IEC 60721-3-2)	2K11 (except condensation and formation of ice)
Long-term storage (IEC 60721-3-1)	1K22 (except condensation and formation of ice)
Classification of mechanical conditions acc. to IEC 60721:	
Stationary use (IEC 60721-3-3)	3M11
Transport (IEC 60721-3-2)	2M4
Long-term storage (IEC 60721-3-1)	1M12

Connection

Connection type	screw-type terminals
Connection properties:	
rigid/flexible	0.2 ... 4 / 0.2 ... 2.5 mm ² (AWG 24 ... 12)
Multi-conductor connection (2 conductors with the same cross section):	
rigid/flexible	0.2 ... 1.5 / 0.2 ... 1.5 mm ²
Stripping length	8 ... 9 mm
Tightening torque	0.5 ... 0.6 Nm
Connection	push-wire terminals
Connection properties:	
Rigid	0.2 ... 2.5 mm ² (AWG 24 ... 14)
Flexible without ferrules	0.75 ... 2.5 mm ² (AWG 19 ... 14)
Flexible with ferrules	0.2 ... 1.5 mm ² (AWG 24 ... 16)
Stripping length	10 mm
Opening force	50 N
Test opening, diameter	2.1 mm

Other

Operating mode	continuous operation
Mounting position	vertically, see dimension diagram
Degree of protection, internal components (DIN EN 60529)	IP30
Degree of protection, terminals (DIN EN 60529)	IP20
Enclosure material	polycarbonate
Flammability class	UL94 V-0
DIN rail mounting acc. to	IEC 60715
Screw fixing	2 x M4 with mounting clip
Software version	D239 V2.3x
Weight	≤240 g

() * = Factory setting

** The technical data are only guaranteed within the operating range of the rated frequency (15...460 Hz).

7.2 Standards, approvals and certifications

7.3 Ordering information

Device type	Nominal voltage U_n^*	Art. No.
VMD421H-D-3	3(N)AC 70...500 V / 288 V, 15...460 Hz	B 7301 0007 (push-wire terminals)
VMD421H-D-3	3(N)AC 70...500 V / 288 V, 15...460 Hz	B 9301 0007
*Absolute values of the voltage range		
Mounting clip for screw mounting (1 piece per device, accessories)		B 9806 0008

7.4 Change log

Date	Document-version	Software version	Changes
06/2021	02	D0239 V2.3x	UKCA Certificate, Design, Change log

A

- Adjustable parameters, list 23
- Alarm 1 LED lights 22
- Alarm 2 LED lights 22
- Automatic self test 13

C

- Clearing the fault memory 22

D

- Delay on release toff 14
- Delay times 11, 14
- Device features 11
- Discharging time energy backup on power failure 40
- Display elements in use 21
- Display in standard mode 24

E

- Enter button 22
- Example of parameter setting 26

F

- Factory settings 15, 37
- Fast commissioning for $U_n = 400\text{ V}$ 11
- Fault memory in operating mode on, off or con 11, 14
- Functional description 11

H

- How to use this manual 5

I

- Indication of the alarm state of K1/K2 15
- Installation and connection 17

K

- K1: alarm category assignment 23
- K2: alarm category assignment 23

M

- Malfunction 14
- Manual self test 14
- Menu
 - AL (response values) 23
 - HiS (history memory for the first alarm value) 24
 - InF (hard and software version) 24
 - out (output control) 23
 - Set (device control) 24
 - t (timing control) 24
- Menu item LEd 15
- Menu structure, overview 23
- Mounting clip for screw mounting 42

O

- Operating elements, function 22
- Operation and settings 21
- Ordering information 42

P

- Parameter query and setting, overview 25
- Parameter setting
 - Assigning alarm categories to the alarm relays 30
 - Enable fault memory 29
 - Enabling or disabling the password protection 34
 - Response value setting 27
 - Select measurement method: Phase-N or Phase-Phase 34
 - Setting delay times 33
 - Setting the operating mode of the alarm relays 30
- Password protection 15

Present measured values

- Asymmetry 24
- Nominal frequency 24
- Phase sequence 24
- Phase-to-phase voltage 24

Preset function 13

R

- Reset button 22
- Response delay ton 14
- Response value setting
 - Asymmetry 28
 - Hysteresis frequency 29
 - Hysteresis U 27
 - Overfrequency ($> \text{Hz}$) 29
 - Phase sequence 28
 - Underfrequency ($< \text{Hz}$) 28
 - Undervoltage ($< U$) und Überspannung ($> U$) 27

S

- Service 5
- Simulated alarm 15
- Starting the menu mode 22
- Start-up delay t 14
- Support 5

T

- Technical data 39
- Test button 22
- Training courses 6

W

- Wiring diagram 19
- Work activities on electrical installations 9
- Workshops 6



Bender GmbH & Co. KG

Postfach 1161 • 35301 Grünberg • Germany
Londorfer Str. 65 • 35305 Grünberg • Germany
Tel.: +49 6401 807-0 • Fax: +49 6401 807-259
E-Mail: info@bender.de • www.bender.de

© Bender GmbH & Co. KG
All rights reserved.
Reproduction only with permission of the publisher.
Subject to alterations!

Photos: Bender archives



BENDER Group