



EN Manual

RCMA423-DM



Residual current monitor

with one analogue output signal
for monitoring AC-, DC- and pulsed DC currents
in TN- and TT systems

Software version: D330 V1.0x



Bender GmbH & Co. KG

P.O. Box 1161 • 35301 Gruenberg • Germany
Londorfer Strasse 65 • 35305 Gruenberg • Germany
Tel.: +49 6401 807-0 • Fax: +49 6401 807-259
E-Mail: info@bender.de • www.bender.de

© Bender GmbH & Co. KG

All rights reserved.
Reprinting only with permission of the publisher.
Subject to change!

Photos: Bender archives

Table of Contents

1. Important information	7
1.1 How to use this manual	7
1.2 Technical support: service and support	8
1.2.1 First level support	8
1.2.2 Repair service	8
1.2.3 Field service	9
1.3 Training courses	10
1.4 Delivery conditions	10
1.5 Inspection, transport and storage	10
1.6 Warranty and liability	11
1.7 Disposal	12
2. Safety instructions	13
2.1 General safety instructions	13
2.2 Work activities on electrical installations	13
2.3 Intended use	13
2.4 Information regarding factory setting	14
3. Function	15
3.1 Device features	15
3.2 Function description	15
3.2.1 Connection monitoring	16
3.2.2 Quick query of the response values	16
3.2.3 Automatic self test	16
3.2.4 Manual self test	16
3.2.5 Malfunction	17
3.2.6 Specifying the number of reload cycles	17
3.2.7 Start-up delay t	17
3.2.8 Residual current monitoring in window mode	17

3.2.9	Password protection (on, OFF)	17
3.2.10	Factory setting FAC	17
3.2.11	Erasable history memory	17
3.2.12	Fault memory	18
3.2.13	Interface	18
4.	Installation and connection	19
4.1	Mounting	20
4.2	Wiring	20
5.	Operation and setup	23
5.1	Display elements	23
5.2	Function of the operating elements	24
5.3	Menu structure	25
5.4	Display in standard mode	26
5.5	Display in menu mode	27
5.5.1	Querying and setting parameters: Overview	27
5.5.2	Parameter settings	29
5.5.3	Changeover from overcurrent to undercurrent mode or to window mode	29
5.5.4	Response value setting for overcurrent:	30
5.5.5	Setting the fault memory to "con" mode	31
5.5.6	Setting the number of reload cycles	31
5.5.7	Selecting output current range of the analogue interface	31
5.5.8	Selecting the output voltage of the analogue interface	32
5.5.9	Setting the 100% reference for the analogue interface	33
5.5.10	Setting delay times	34
5.5.11	Changing from overcurrent operation to window operation	34
5.5.12	Factory setting and password protection	35
5.5.13	Restoring the factory settings	36
5.5.14	Querying device information	37
5.5.15	Querying the history memory	37

5.6	Commissioning	37
5.7	Factory setting	38
6.	Technical data	39
6.1	Tabular data	39
6.2	Standards, approvals and certifications	43
6.3	Ordering information	44
6.3.1	RCMA423...	44
6.3.2	External measuring current transformers	44
6.3.3	Connecting wires measuring current transformer	44
6.3.4	Accessories RCMA423-DM	44
6.3.5	Measuring current transformer accessories	45
6.4	Current and voltage curves of the analogue interface	45
6.5	Error codes	46
INDEX	49

1. Important information

1.1 How to use this manual



*This manual is intended for **qualified personnel** working in electrical engineering and electronics!*

Always keep this manual within easy reach for future reference.

To make it easier for you to understand and revisit certain sections in this manual, we have used symbols to identify important instructions and information. The meaning of these symbols is explained below:



*This signal word indicates that there is a **high risk of danger** that will result in **electrocution** or **serious injury** if not avoided.*



*This signal word indicates a **medium risk of danger** that can lead to **death** or **serious injury** if not avoided.*



*This signal word indicates a **low level risk** that can result in **minor** or **moderate injury or damage to property** if not avoided.*



*This symbol denotes information intended to assist the user in making **optimum use** of the product.*

This manual has been compiled with great care. It might nevertheless contain errors and mistakes. Bender cannot accept any liability for injury to persons or damage to property resulting from errors or mistakes in this manual.

1.2 Technical support: service and support

For commissioning and troubleshooting Bender offers you:

1.2.1 First level support

Technical support by phone or e-mail for all Bender products

- Questions concerning specific customer applications
- Commissioning
- Troubleshooting

Telephone: +49 6401 807-760*
Fax: +49 6401 807-259
In Germany only: 0700BenderHelp (Tel. and Fax)
E-mail: support@bender-service.de

1.2.2 Repair service

Repair, calibration, update and replacement service for Bender products

- Repairing, calibrating, testing and analysing Bender products
- Hardware and software update for Bender devices
- Delivery of replacement devices in the event of faulty or incorrectly delivered Bender devices
- Extended guarantee for Bender devices, which includes an in-house repair service or replacement devices at no extra cost

Telephone: +49 6401 807-780** (technical issues)
+49 6401 807-784**, -785** (sales)
Fax: +49 6401 807-789
E-mail: repair@bender-service.de

Please send the devices for **repair** to the following address:

Bender GmbH, Repair-Service,
Londorfer Str. 65,
35305 Gruenberg

1.2.3 Field service

On-site service for all Bender products

- Commissioning, configuring, maintenance, troubleshooting of Bender products
- Analysis of the electrical installation in the building (power quality test, EMC test, thermography)
- Training courses for customers

Telephone: +49 6401 807-752**, -762 **(technical issues)
+49 6401 807-753** (sales)
Fax: +49 6401 807-759
E-mail: fieldservice@bender-service.de
Internet: www.bender-de.com

*Available from 7.00 a.m. to 8.00 p.m. 365 days a year (CET/UTC+1)

**Mo-Thu 7.00 a.m. - 8.00 p.m., Fr 7.00 a.m. - 13.00 p.m

1.3 Training courses

Bender is happy to provide training regarding the use of test equipment. The dates of training courses and workshops can be found on the Internet at www.bender-de.com -> Know-how -> Seminars.

1.4 Delivery conditions

Bender sale and delivery conditions apply.

For software products the "Softwareklausel zur Überlassung von Standard-Software als Teil von Lieferungen, Ergänzung und Änderung der Allgemeinen Lieferbedingungen für Erzeugnisse und Leistungen der Elektroindustrie" (software clause in respect of the licensing of standard software as part of deliveries, modifications and changes to general delivery conditions for products and services in the electrical industry) set out by the ZVEI (Zentralverband Elektrotechnik- und Elektronikindustrie e. V.) (German Electrical and Electronic Manufacturer's Association) also applies.

Sale and delivery conditions can be obtained from Bender in printed or electronic format.

1.5 Inspection, transport and storage

Inspect the dispatch and equipment packaging for damage, and compare the contents of the package with the delivery documents. In the event of damage in transit, please contact Bender immediately.

The devices must only be stored in areas where they are protected from dust, damp, and spray and dripping water, and in which the specified storage temperatures can be ensured.

1.6 Warranty and liability

Warranty and liability claims in the event of injury to persons or damage to property are excluded if they can be attributed to one or more of the following causes:

- Improper use of the device.
- Incorrect mounting, commissioning, operation and maintenance of the device.
- Failure to observe the instructions in this operating manual regarding transport, commissioning, operation and maintenance of the device.
- Unauthorised changes to the device made by parties other than the manufacturer.
- Non-observance of technical data.
- Repairs carried out incorrectly and the use of replacement parts or accessories not approved by the manufacturer.
- Catastrophes caused by external influences and force majeure.
- Mounting and installation with device combinations not recommended by the manufacturer.

This operating manual, especially the safety instructions, must be observed by all personnel working on the device. Furthermore, the rules and regulations that apply for accident prevention at the place of use must be observed.

1.7 Disposal

Abide by the national regulations and laws governing the disposal of this device. Ask your supplier if you are not sure how to dispose of the old equipment.

The directive on waste electrical and electronic equipment (WEEE directive) and the directive on the restriction of certain hazardous substances in electrical and electronic equipment (RoHS directive) apply in the European Community. In Germany, these policies are implemented through the "Electrical and Electronic Equipment Act" (ElektroG). According to this, the following applies:

- Electrical and electronic equipment are not part of household waste.
- Batteries and accumulators are not part of household waste and must be disposed of in accordance with the regulations.
- Old electrical and electronic equipment from users other than private households which was introduced to the market after 13 August 2005 must be taken back by the manufacturer and disposed of properly.

For more information on the disposal of Bender devices, refer to our homepage at www.bender-de.com -> Service & support.

2. Safety instructions

2.1 General safety instructions

Part of the device documentation in addition to this manual is the enclosed "Safety instructions for Bender products".

2.2 Work activities on electrical installations



Only **qualified personnel** are permitted to carry out the work necessary to install, commission and run a device or system.



DANGER

Risk of electrocution due to electric shock!

Touching live parts of the system carries the risk of:

- An electric shock
- Damage to the electrical installation
- Destruction of the device

Before installing and connecting the device, make sure that the installation has been *de-energised*. Observe the rules for working on electrical installations.

If the device is used outside the Federal Republic of Germany, the applicable local standards and regulations must be complied with. The European standard EN 50110 can be used as a guide.

2.3 Intended use

The AC/DC sensitive residual current monitoring device RCMA423-DM is used for monitoring of earthed systems (TN and TT systems), in which DC or AC fault currents can occur. Part of these systems are particularly loads contain-

ning six-pulse rectifiers or one-way rectifiers with smoothing, such as converters, battery chargers, construction site equipment with frequency-controlled drives.

Two separately adjustable response value ranges allow a distinction between prewarning ($I_{\Delta n1} = 50 \dots 100\%$ of the set response value $I_{\Delta n2}$) and alarm ($I_{\Delta n2}$). Since the values are measured with measuring current transformers, the residual current monitoring device is almost independent of the nominal voltage and the current of the monitored system.

This option provides an analogue interface with galvanic isolation. One of three output signals can be selected from the associated menu. Only use the output you have selected via the software:

- DC 0...400 μ A

Current output for Bender measuring instruments of the 96.. series.

- DC 0/4...20 mA

Standardised current output with selectable current ranges.

- DC 0...10 V

Standardised voltage signal.

In order to meet the requirements of the applicable standards, customised parameter settings must be made on the equipment in order to adapt it to local equipment and operating conditions. Please heed the limits of the range of application indicated in the technical data.

Any use other than that described in this manual is regarded as improper.

2.4 Information regarding factory setting

Page 38 provides a summary of all factory settings.

If you want to reset the residual current monitor to its factory setting in a specific case, refer to Page 36.

3. Function

3.1 Device features

- AC/DC sensitive residual current monitor type B acc. to IEC 62020 and IEC/TR 60755
- Two separately adjustable response value ranges (prewarning, alarm)
- Adjustable switching hysteresis
- r.m.s. value measurement
- Start-up delay
- Measured value indication via multi-functional LCD
- Alarm indication via LEDs (AL1, AL2) and analogue interface
- Password protection to prevent unauthorised parameter changes
- The fault memory can be deactivated
- CT connection monitoring
- Manual self test of device and transformer with a genuine test current

3.2 Function description

After connecting the supply voltage U_s , the start-up delay is active. The residual current is measured via an external measuring current transformer from the W20AB...W210AB type series. The currently measured insulation resistance is indicated on the LC display. This way any changes, for example when outgoing circuits are connected to the system, can be recognised easily. If the set response values are exceeded, the alarm LEDs AL1/AL2 light up. In addition, a proportional voltage or current signal is emitted by the analogue output that has been preselected via the menu. Refer also to "chapter 3.2.13 Interface".

If the residual current falls below the release value (response value minus hysteresis), the alarm LEDs AL1/AL2 go out. If the fault memory is activated, the LEDs stay lit until the **reset button R** is pressed or until the power supply is interrupted.

The device function can be tested using the **test button T**. Parameters are assigned to the device via the LCD and the control buttons on the front panel; this function can be password-protected.

3.2.1 Connection monitoring

The connections to the measuring current transformer are constantly monitored. In the event of a fault, the alarm LEDs AL1/AL2/ON flash (Error Code E.01).

3.2.2 Quick query of the response values

When the display is in standard mode, the current response values $I_{\Delta n1}$ and $I_{\Delta n2}$ can be queried by using the arrow-up and arrow-down button (< 1.5 s). Switching over to the menu mode is not necessary. Press the enter button to exit the quick query.

3.2.3 Automatic self test

The device automatically carries out a self test after connecting to the system to be monitored and later every 24 hours. During the self test internal functional faults will be detected and appear in form of an error code on the display.

3.2.4 Manual self test

While holding down the test button T, all device-relevant display elements appear on the display.

The device runs a self test when the test button is pressed > 1.5 s. Any internal malfunctions detected during this test are shown on the display as error codes.

In addition, a test current is injected via connection T of the measuring current transformer. It exceeds the response value set on the RCMA. As long as no malfunctions are detected during the self test, all three LEDs stay lit. After the test has been completed successfully, the yellow LEDs go out. If the test current does not exceed the set response value, the yellow LEDs flash and the error code E.02 appears in the display.

3.2.5 Malfunction

In the event of an internal malfunction, all three LEDs will flash. The display shows an error code (E01...E32). In such a case please contact the Bender Service.

3.2.6 Specifying the number of reload cycles

If an error occurs in the monitored system and the system has to be switched off by the alarm relay, with the fault memory M deactivated the alarm relay would switch synchronously to the error status. RL in the out menu can be used to limit the number of these changeover processes. As soon as the preset number of switching cycles is exceeded, the fault memory will come on and an activated alarm remains stored.

3.2.7 Start-up delay t

After connection to the supply voltage U_s the alarm indication is delayed by the preset time t (0...10 s).

3.2.8 Residual current monitoring in window mode

By switching the measurement method to window mode (SEt/In) the device triggers an alarm when exiting the mode, which is generated by the response values I1 and I2; (see Page 34).

3.2.9 Password protection (on, OFF)

If password protection has been enabled (on), settings can only be made subject to the correct password being entered (0...999).

3.2.10 Factory setting FAC

Activating the factory setting will reset all previously changed settings to the default upon delivery.

3.2.11 Erasable history memory

The first alarm value to occur is written to this memory. The memory can be erased via the HiS menu.

External, combined test or reset button T/R

Reset= Pressing the external button < 1.5 s

Test = Pressing the external button > 1.5 s

3.2.12 Fault memory

The fault memory can be activated, deactivated or set to continuous mode (con). In "con" mode, the alarm remains stored even after failure of the supply voltage. Stored alarms can be reset by means of the reset button R.

3.2.13 Interface

The device provides an analogue interface **with galvanic isolation**. One of three output signals can be selected from the corresponding menu. To avoid any faults (full-scale deflection of the connected measuring device), only the output selected via the software may be terminated:

- DC 0...400 μ A
Current output for Bender measuring instruments of series 96...
- DC 0...20 mA/4...20 mA
Standardised current output with two selectable ranges
- DC 0...10 V
Standard voltage signal

4. Installation and connection



DANGER

Ensure that there is **no voltage** in the installation area and follow the rules for working on electrical equipment!

Dimension diagram, drawing for screw fixing, push-wire terminal connection

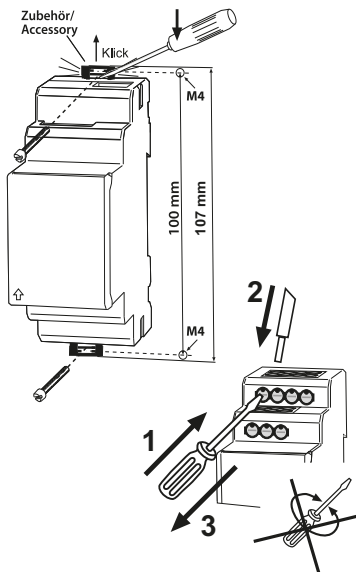
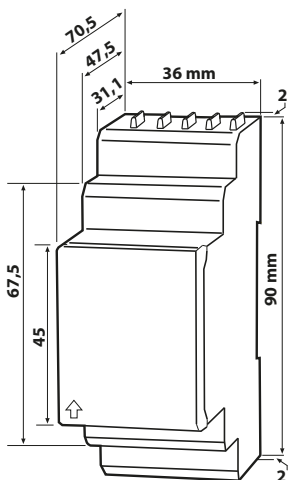

The front plate cover can be opened at the lower part marked with an arrow.

4.1 Mounting

1. DIN rail:

Snap the rear mounting clip of the device into place in such a way that a safe and tight fit is ensured.

2. Screw fixing:

Use a tool to position the rear mounting clips so that they project beyond the enclosure (a second mounting clip is required, see ordering information). Then fix the device using two M4 screws.

4.2 Wiring

Connect the device according to the wiring diagram.

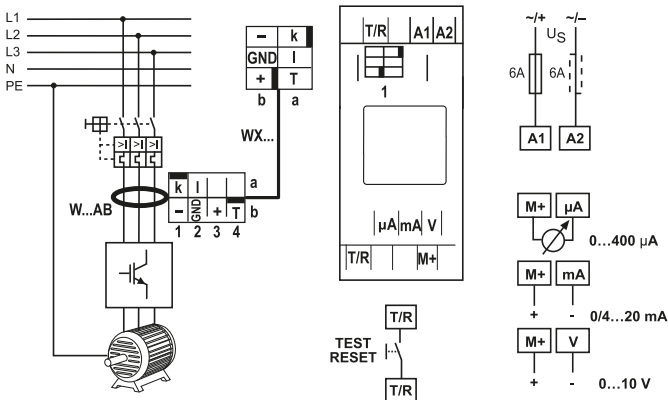

Fig. 4.1: Wiring diagram RCMA423-DM



Legend for wiring diagram RCMA423-DM

Terminal	Connections
A1, A2	Connection to supply voltage U_s
k, l	Connection for measuring current transformer
T/R	Connection to combined test and reset button
M+	(Common) positive pole of the analogue interface
μA	Current output 0...400 μ A
mA	Current output 0...20 mA/4...20 mA
V	Voltage output 0...10 V

5. Operation and setup

5.1 Display elements

The meaning of the display elements in use is listed in the table below.

Display elements	Element	Function
	RL	Reload function with memory = off (L = I.)
	I2	Response value $I_{\Delta n2}$ in mA (alarm 2, main alarm)
	I1	Response value $I_{\Delta n1}$ in % of $I_{\Delta n2}$ (alarm 1, prewarning)
	I Hys, %	Response value hysteresis in %
	t	Start-up delay t
	M	Fault memory active
		Password protection enabled

5.2 Function of the operating elements

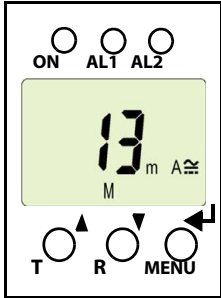
User interface	Element	Function
	ON, green	is continuously lit: Power On LED, flashes: system fault or malfunction of connection monitoring
	AL1, AL2	LED alarm 1 is lit (yellow): Response value 1 has been reached ($I_{\Delta n1}$) LED alarm 2 is lit (yellow): Response value 2 has been reached ($I_{\Delta n2}$)
	13 mA M	13 mA flow through the measuring current transformer, Fault memory active
	T, ▲	Test button (> 1.5 s): Indicating display elements availa- ble for this device, starting a self test; Arrow-up button (< 1.5 s): Menu items/values
	R, ▼	Reset button (> 1.5 s): Erasing the fault memory; Arrow-down button (< 1.5 s): Menu items/values
	MENU, ◀	MENU button (> 1.5 s): Starting the menu mode; Enter button (< 1.5 s): Confirming menu item, submenu item and value. Enter button (> 1.5 s): Back to the next higher menu level.

5.3 Menu structure

All adjustable parameters are listed in the columns Menu and Adjustable parameter.

A display-like representation is used to illustrate the parameters in the column Menu.

Menu	Submenu	Menu item	Activation	Adjustable parameter
AL (response values)	→	> I2	- (HI)	$I_{\Delta n2}$ (alarm 2)
		> I1	- (HI)	$I_{\Delta n1}$ in % of $I_{\Delta n2}$ (alarm 1, prewarning)
		Hys	-	Hysteresis $I_{\Delta n1} / I_{\Delta n2}$
out (output control)	→	M	-	Fault memory
		I, U	-	Selection current/voltage 0...400 μ A/0...20 mA/ 4...20 mA/0...10 V
	AnA Analogue outp.: 100 % value	I2 AL	-	100% reference related to response value I2 (alarm 2)
		I	-	100 % reference related to user-defined current value: I
t (timing control)	→	t	-	Start-up delay
Set (device control)	→	I I2	HI	Selectable parameters: High, Window function, Low
			OFF	Set parameters via password
		FAC	-	Restore factory settings
		SYS	-	Function locked

Menu	Submenu	Menu item	Activation	Adjustable parameter
InF	→		-	Display hardware/software version
HiS	→	Clr	-	History memory for the first alarm value, erasable

Tab. 5.1: Menu structure RCMA423-DM

5.4 Display in standard mode

The currently measured residual current is indicated in the factory setting. By pressing the arrow-up and arrow-down button, the current response values I1 (prewarning) and I2 (alarm) are displayed. Press enter to return to the measured value.

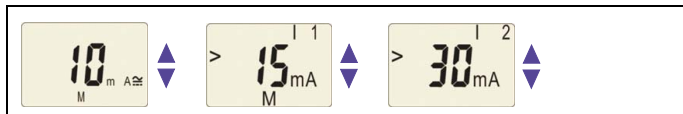

In standard mode, the current response values I1 and I2 can be displayed using the arrow-up and arrow-down buttons.

5.5 Display in menu mode

5.5.1 Querying and setting parameters: Overview

Menu item	Adjustable parameter
AL	Querying and setting response values: <ul style="list-style-type: none"> - Residual current $I_{\Delta n2}$ (AL2) - Residual current $I_{\Delta n1}$ (AL1) - Hysteresis of the response values: % Hys
out	Configuring fault memory: <ul style="list-style-type: none"> - Activate/deactivate fault memory - Select output signal - Specify number of reload cycles - Select 100 % reference related to the output signal (AnA)
t	Setting start-up delay t
SEt	Setting parameters for device control: <ul style="list-style-type: none"> - Selectable parameters for response values: Overcurrent operation (HI), undercurrent operation (Lo) or window function (In) - Activate or deactivate password protection, change password - Restore factory settings - Service menu SyS (blocked)
InF	Query hardware and software version
HiS	Query the alarm value saved first
ESC	Move to the next higher menu level (back)

Tab. 5.2: Querying and setting parameters: Overview

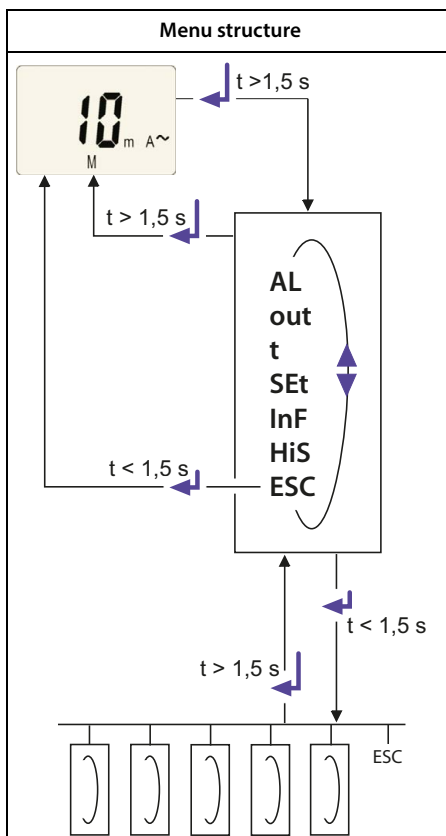

5.5.2 Parameter settings

By way of example, the modification of the alarm response value I1 ($I_{\Delta n1}$) is described. It is presumed that the option overcurrent (HI) has been selected in the SEt/I12 menu (factory setting). Proceed as follows:

1. Keep the MENU/Enter button pressed for more than 1.5 seconds. The flashing short symbol AL appears on the display.
2. Confirm with Enter. The parameter response value > I2 flashes; in addition, the associated response value of 30 mA appears.
3. Press the arrow-down button to select the response value I1. The parameter I1 flashes; in addition, the associated percentage value for prewarning 50 % of I2 appears.
4. Confirm with Enter. The current value for prewarning flashes.
5. Use the arrow-up or arrow-down button to set the appropriate prewarning value. Confirm with Enter. I1 flashes.
6. You can exit the menu by:
 - pressing the Enter button for more than 1.5 seconds to reach the next higher level or
 - selecting the menu item ESC and confirming with Enter to reach the next higher level.



The areas of the display that can be configured flash! This is indicated by an oval in the illustrations below. Press and hold down the MENU button > 1.5 s to enter menu mode.

5.5.3 Changeover from overcurrent to undercurrent mode or to window mode

The changeover of the operating mode can be set in the SEt/I12 menu using the parameters HI, Lo and In. By default, overcurrent operation (HI) is set. Refer to Page 34 for a detailed description on how to change over to the window mode.

5.5.4 Response value setting for overcurrent:

- Response value I2 (overcurrent)
- Response value I1 (prewarning overcurrent)
- Hysteresis (Hys) of the response values I1, I2

Increasing the response value I2 (Example: overcurrent)

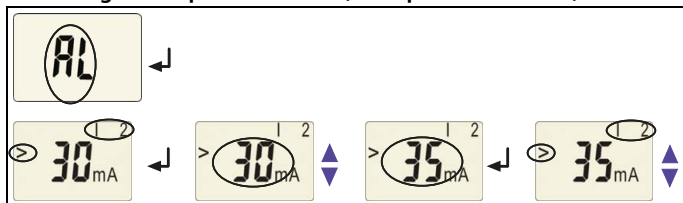

Increasing the response value I1 (prewarning overcurrent)

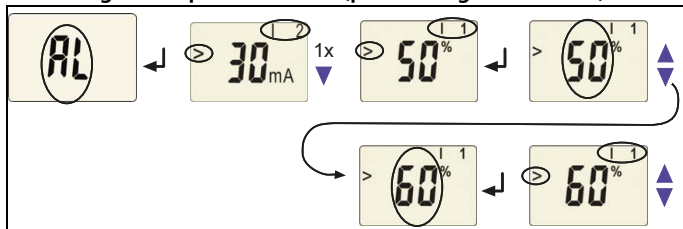

Setting the hysteresis of the response value

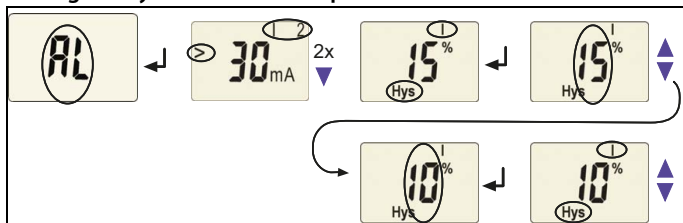

5.5.5 Setting the fault memory to "con" mode

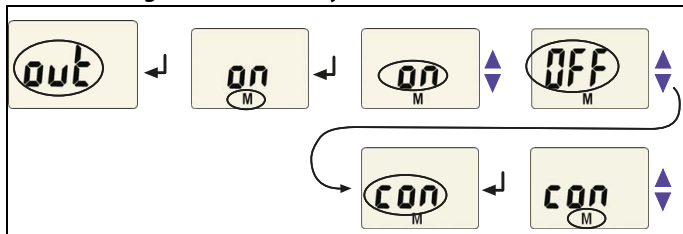

5.5.6 Setting the number of reload cycles

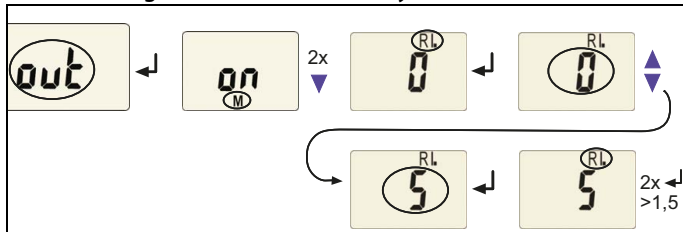

5.5.7 Selecting output current range of the analogue interface

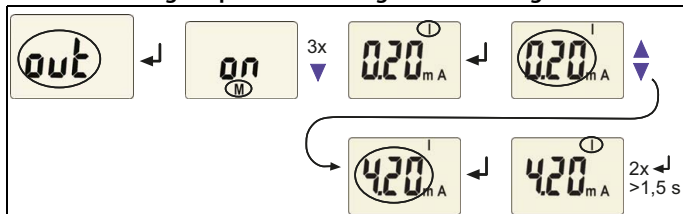

0.04 mA represents 0...400 μ A

0.20 mA represents 0...20 mA; 4.20 mA represents 4...20 mA

5.5.8 Selecting the output voltage of the analogue interface

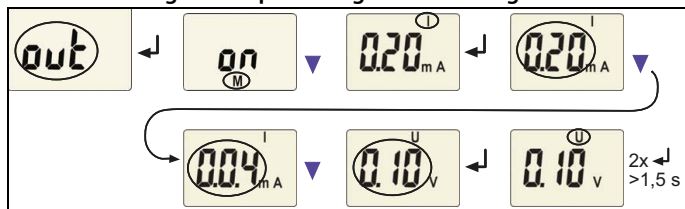

0.10 V represents 0...10 V

5.5.9 Setting the 100% reference for the analogue interface

Set here whether the 100% value of the output signal is to be coupled to the response value I2 ($I_{\Delta n2}$) (AL) or to a freely configurable value. A configurable value range from 30mA to 3A is available.

Factory setting = coupling to response value I2 ($I_{\Delta n2}$) (AL).

The following example shows the modification of the 100% reference of AL = coupling to response value on a 100% value of 60 mA.

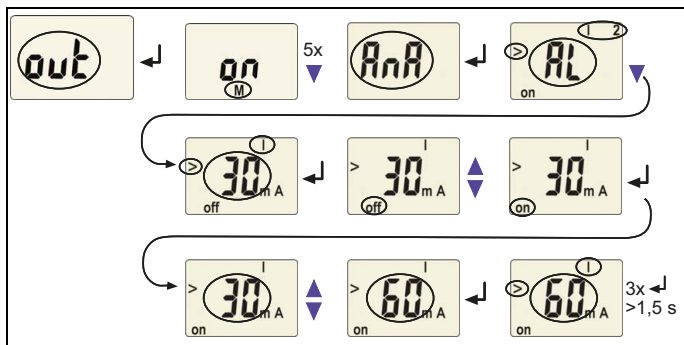

5.5.10 Setting delay times

The following delays can be set:

- Start-up delay t (0...10 s) when starting the device

Setting the start-up delay t

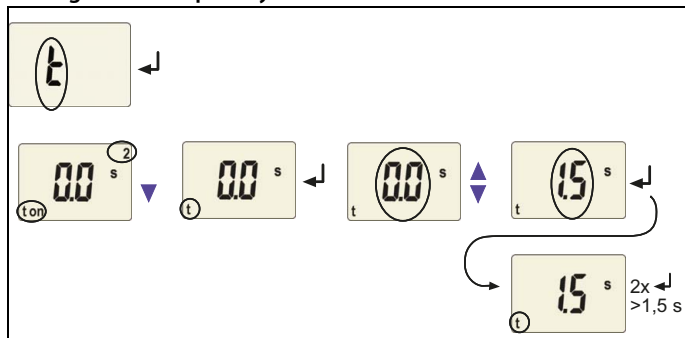

5.5.11 Changing from overcurrent operation to window operation

Use this menu item to set whether the response values of the device apply to overcurrent (HI) or undercurrent operation (Lo). In addition, window operation (In) can be selected.

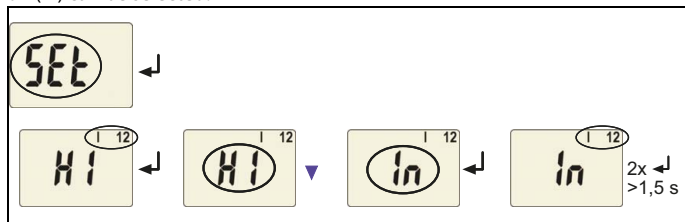

5.5.12 Factory setting and password protection

This menu can be used to activate the password protection, to modify the password or to deactivate the password protection. It is also where the device can be reset to the factory settings.

a) Activating the password protection

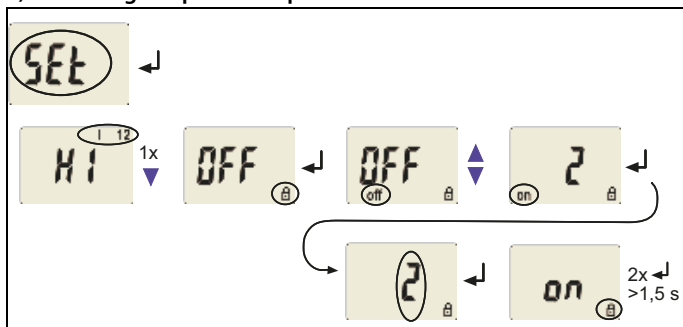

b) Changing the password

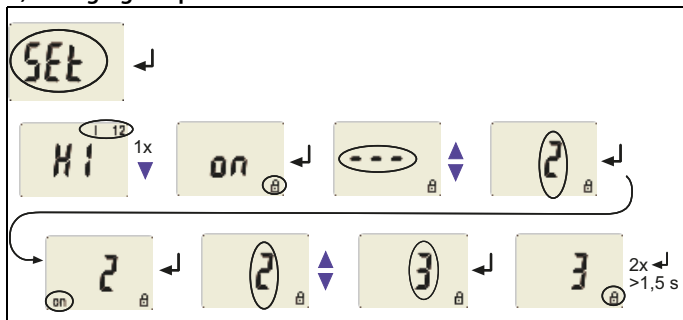

c) Deactivating the password protection

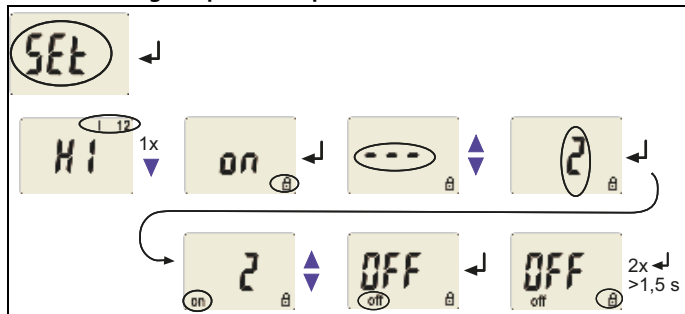

5.5.13 Restoring the factory settings

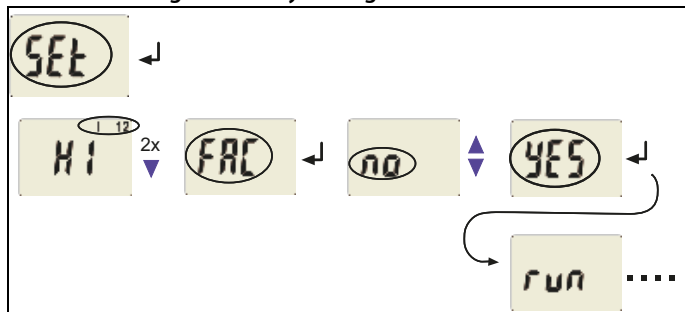

5.5.14 Querying device information

This function is used to query the software version (1.xx). After activating this function, data will be displayed as a scrolling text. Once one pass is completed you can select individual data sections using the arrow-up/arrow-down buttons.

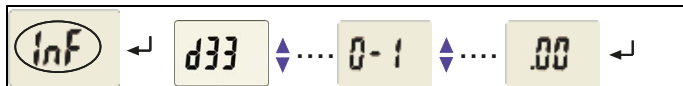

5.5.15 Querying the history memory

Select the history memory via the menu HiS. Use the arrow-up and arrow-down buttons to view the next display. If Clr is flashing, the history memory can be cleared by pressing the Enter button.

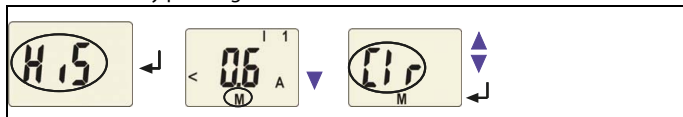

5.6 Commissioning

Prior to commissioning, check proper connection of the residual current monitoring device.

5.7 Factory setting



<i>Response value $I_{\Delta n2}$</i>	<i>30 mA (I2)</i>
<i>Response value $I_{\Delta n1}$</i>	<i>50 % (I1)</i>
<i>Hysteresis</i>	<i>15 %</i>
<i>Fault memory M</i>	<i>activated (on)</i>
<i>RL (Reload function)</i>	<i>0</i>
<i>100% reference for the analogue interface</i>	<i>Response value I2</i>
<i>Start-up delay</i>	<i>t = 0.5 s</i>
<i>Password</i>	<i>0, deactivated (Off)</i>

6. Technical data

6.1 Tabular data

()* = factory setting

Insulation coordination acc. to IEC 60664-1/IEC 60664-3

RCMA423-DM-1:

Rated insulation voltage.....	100 V
Overtoltage category/pollution degree	III/3
Rated impulse withstand voltage	2.5 kV

RCMA423-DM-2:

Rated insulation voltage.....	250 V
Overtoltage category/pollution degree	III/3
Rated impulse withstand voltage	4 kV

Supply voltage

RCMA423-DM-1:

Supply voltage range U_s	AC 24...60 V/DC 24...78 V
Operating range supply voltage U_s	AC 16...72 V/DC 9.6...94 V
Frequency range f_s	DC, 42...460 Hz

RCMA423-DM-2:

Supply voltage range U_s	AC/DC 100...250 V
Operating range supply voltage U_s	AC/DC 70...300 V
Frequency range f_s	DC, 42...460 Hz

Protective separation (reinforced insulation) between..... (A1, A2) - (k/l, T/R) - (M+, μ A, V)

Voltage tests according to IEC 61010-1..... 2.21 kV

Power consumption

.....	≤ 6.5 VA
-------	---------------

Measuring circuit

External measuring current transformer type..... W20AB, W35AB(P), W60AB(P), W120AB, W210AB

Rated insulation voltage (measuring current transformer)

.....	800 V
-------	-------

Operating characteristics acc. to IEC 62020 and IEC/TR 60755..... type B

Rated frequency..... 0...2000 Hz

Measuring range AC/DC..... 3 mA...6 A

Relative uncertainty at $f \leq 2$ Hz or ≥ 16 Hz	0 ... -35 %
Relative uncertainty at $f > 2$ Hz ... < 16 Hz	-35 % ... +100 %
Operating uncertainty	0 ... 35 %

Response values

Rated residual operating current $I_{\Delta n1}$ (prewarning, AL1)	50 ... 100 % $\times I_{\Delta n2}$ (50 %)*
Rated residual operating current $I_{\Delta n2}$ (alarm, AL2)	30 mA ... 3 A (30 mA)*
Hysteresis	10 ... 25 % (15 %)*

Time response

Start-up delay t	0 ... 10 s (0.5 s)*
Recovery time t_b	≤ 300 ms
Number of reload cycles	0 ... 100 (0)*

Cable lengths for measuring current transformers

Connecting cable WX ... (see ordering information on Page 44)	1 m/2.5 m/5 m/10 m
Alternatively: single wire $6 \times 0.75 \text{ mm}^2$	0 ... 10 m

Displays, memory

Display range measured value AC/DC	0 ... 6 V
Error of measured value indication	± 17.5 %/ ± 2 digits
Measured-value memory for alarm value	Data record measured values
Password	off/0 ... 999 (off)*
Fault memory	on/off (on)*

Inputs/outputs

Cable length for external test/reset button	0... 10 m
Voltage output	
Open circuit voltage (terminals open)	≤ DC 20 V
Voltage output	DC 0... 10 V
Load	≥ 1 kΩ
Resolution	50 mV
Tripping time $1 \times I_{\Delta n}$	> 1.8 s
Tripping time $5 \times I_{\Delta n}$	> 360 ms
Current outputs:	
Short-circuit current	≤ 30 mA, short-circuit proof
Current output	DC 0/4... 20 mA
Load	≤ 500 Ω
Resolution	0.1 mA
Tripping time $1 \times I_{\Delta n}$	> 1.8 s
Tripping time $5 \times I_{\Delta n}$	> 360 ms
Current output	DC 0... 400 μA
Load	≤ 12.5 kΩ
Resolution	2 μA
Tripping time $1 \times I_{\Delta n}$	> 1.8 s
Tripping time $5 \times I_{\Delta n}$	> 360 ms

Environment/EMC

EMC	IEC 62020
Operating temperature	-25 °C... +55 °C
Classification of climatic conditions acc. to IEC 60721:	
Stationary use (IEC 60721-3-3)	3K5 (except condensation and formation of ice)
Transport (IEC 60721-3-2)	2K3 (except condensation and formation of ice)
Storage (IEC 60721-3-1)	1K4 (except condensation and formation of ice)
Classification of mechanical conditions acc. to IEC 60721:	
Stationary use (IEC 60721-3-3)	3M4
Transport (IEC 60721-3-2)	2M2
Long-term storage (IEC 60721-3-1)	1M3

Connection

For UL applications: Copper lines at least 60/70 °C

Connection type **screw-type terminals**

Connection properties:

Rigid/flexible 0.2 ... 4/0.2 ... 2.5 mm² (AWG 24 ... 12)

Multi-conductor connection (2 conductors with the same cross section):

Rigid/flexible 0.2 ... 1.5/0.2 ... 1.5 mm²

Stripping length 8 ... 9 mm

Tightening torque 0.5 ... 0.6 Nm

Connection type **push-wire terminals**

Connection properties:

Rigid 0.2 ... 2.5 mm² (AWG 24 ... 14)

Flexible without ferrules 0.2 ... 2.5 mm² (AWG 24 ... 14)

Flexible with ferrules 0.2 ... 1.5 mm² (AWG 24 ... 16)

Stripping length 10 mm

Opening force 50 N

Test opening, diameter 2.1 mm

Other

Operating mode continuous operation

Mounting display oriented

Degree of protection, built-in components (DIN EN 60529) IP30

Degree of protection, terminals (IEC 60529) IP20

Enclosure material polycarbonate

Flammability class UL 94 V-0

DIN rail mounting IEC 60715

Screw fixing 2 x M4 with mounting clip

Software version D330 V1.0x

Weight ≤ 160 g

() * = factory setting

Residual operating current ranges of the different measuring current transformer

Residual operating current ranges	Typ.
30 mA...500 mA	W20AB
30 mA...3 A	W35AB(P) W60AB(P) W120AB
300 mA...3 A	W210AB

6.2 Standards, approvals and certifications

The device was designed according to the following standards:

- IEC 62020
- IEC/TR 60755

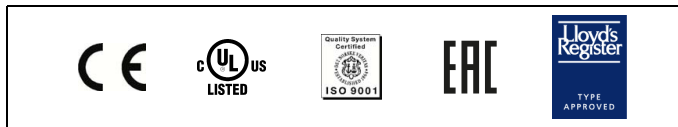

6.3 Ordering information

6.3.1 RCMA423...

	RCMA423-DM-1	RCMA423-DM-2
Response range $I_{\Delta n}$	30 mA...3 A	
Rated frequency	0...2000 Hz	
Supply voltage U_s^*	DC 9.6 V...94 V/ AC 42...460 Hz, 16...72 V	DC 70...300 V/ AC 42...460 Hz, 70...300 V
Art. no. RCMA423DM (B7... = push-wire terminal)	B 7404 3026 B 9404 3026	B 7404 3030 B 9404 3030
*Absolute values of the voltage range		

6.3.2 External measuring current transformers

Type	Internal diameter (mm)	Art. no.
W20AB	20	B 9808 0008
W35AB	35	B 9808 0016
W35ABP	35	B 9808 0051
W60AB	60	B 9808 0026
W60ABP	60	B 9808 0052
W120AB	120	B 9808 0041
W210AB	210	B 9808 0040

6.3.3 Connecting wires measuring current transformer

Type	Length (m)	Art. no.
WX-100	1	B 9808 0503
WX-250	2.5	B 9808 0504
WX-500	5	B 9808 0505
WX-1000	10	B 9808 0506

6.3.4 Accessories RCMA423-DM

Mounting clip for screw fixing (1 piece per device) B 9806 0008

6.3.5 Measuring current transformer accessories

Snap-on mounting for DIN rail: W20AB /W35AB(P) B 9808 0501

Snap-on mounting for DIN rail: W60AB(P) B 9808 0502

6.4 Current and voltage curves of the analogue interface

Current output 0/4...20 mA

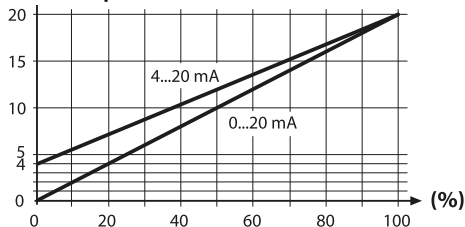

Current output 0...400 µA

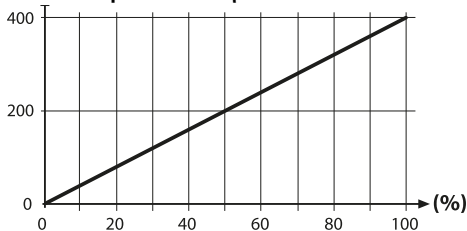

Voltage output 0...10 V

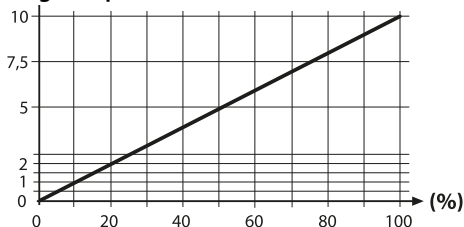

6.5 Error codes

If, contrary to expectations, a device error should occur, error codes will appear on the display. Some of these are described below:

Error code	Meaning
E.01	Fault CT monitoring Action: Check transformer connection for short-circuit or interruption. The error code will be erased automatically once the error has been eliminated
E.02	Fault CT monitoring during a manual self-test Action: Check transformer connection for short-circuit or interruption. The error code will be erased automatically once the error has been eliminated

Error code	Meaning
E...	<p>Error codes > 02</p> <p>Action: Perform a reset. Restore the factory setting of the device. The error code will be erased automatically once the error has been eliminated. Should the error persist, contact Bender Service</p>

INDEX

A

- Adjustable parameters, list 25
- Automatic self test 16

D

- Device features 15
- Display elements 23
- Display in standard mode 26

E

- Enter button 24
- Erasing the fault memory 24
- Error codes 46
- Example of parameter setting 29

F

- Factory setting 17, 38
- Function description 15

H

- How to use this manual 7

I

- Installation and connection 19
- Interface options 18

L

- LED alarm 1 is lit 24
- LED alarm 2 is lit 24

M

- Malfunction 17
- Manual self test 16
- Measuring current transformer, residual operating current ranges 43
- Menu
 - AL (response values) 25
 - HiS (history memory for the first alarm value) 26
 - InF (hard and software version) 26
 - out (output control) 25
 - Set (device control) 25
 - t (timing control) 25
- Menu structure, overview 25

O

- Operating elements, function 24
- Operation and setup 23
- Ordering information 44

P

- Parameter setting
 - Activating or deactivating the pass-word protection 35
 - Changing from overcurrent operation to window operation 34
 - Deactivate fault memory 31
 - Response value setting 30
 - Selecting output current range of the

analogue interface 31
- Setting delay times 34
Password protection 17

Wiring diagram 20
Work activities on electrical installations 13
workshops 10

Q

Querying and setting parameters, overview
27

R

Reset button 24
Residual current monitoring in window mode 17
Response value setting
- Hysteresis 30
- Overcurrent (> I) 30

S

Selectable parameters for response values
27
Selecting analogue interface, 31
Service 8
Setting the analogue interface 33
Starting the menu mode 24
Start-up delay t 17
Support 8

T

Technical data 39
Test button 24
Training courses 10

W

Window operation 34



Bender GmbH & Co. KG

Londorfer Str. 65 • 35305 Gruenberg • Germany

Postfach 1161 • 35301 Gruenberg • Germany

Tel.: +49 6401 807-0

Fax: +49 6401 807-259

Email: info@bender.de

www.bender.de

